

BOROUGH OF MILFORD DESIGN GUIDE

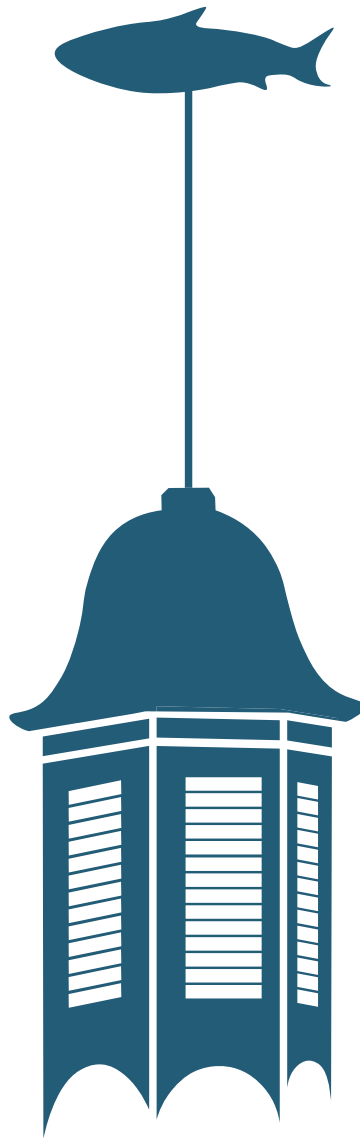

Borough of Milford, Pennsylvania
Milford Historical Architectural Review Board
December 2022

ACKNOWLEDGMENTS

MAYOR

Sean Strub

MILFORD BOROUGH COUNCIL

Joseph Dooley, President
Maria Farrell, Vice President
Peter Cooney
Andrew Jorgenson
George Lutfy
Doug Manion
Dale Thatcher

MILFORD HISTORICAL ARCHITECTURAL REVIEW BOARD

David Lender, Chair
Megan Strub, Vice Chair
Shawn Bolles
Hector Munoz-Baras
Justin Pfaff
Niki Santelli-Wolff
Kevin Stroyan

MILFORD PROJECT ADVISORY TEAM

Adriane Wendell, Project Coordinator
Joseph Dooley
David Lender
Matthew Osterberg
Sean Strub
Frank Tarquinio
Dale Thatcher

The Borough of Milford Design Guide was recommended for adoption by the HARB on December 14, 2022, and adopted by the Borough Council on December 19, 2022.

The *Borough of Milford Design Guide* update was prepared by:

EASTONARCHITECTS

Easton Architects, LLP
New York, NY
Partner-in-Charge: Lisa Easton, AIA

PENNSYLVANIA STATE HISTORIC PRESERVATION OFFICE

Megan McNish, Eastern Region Community Preservation Coordinator
Elizabeth Rairigh, Preservation Services Division Manager

The Project Team gratefully acknowledges Borough Secretary Francesca Lombardo and Past Borough Secretary Laurie DiGeso, the Historic Preservation Trust of Pike County, and all members of the public for their participation in public meetings and contributions to the *Design Guide*.





This project is supported in part with Federal funds from the National Park Service, U.S. Department of the Interior, made available through the Pennsylvania Historical & Museum Commission. However, the contents and opinions do not necessarily reflect the views or policies of the Department of the Interior, or the Pennsylvania Historical & Museum Commission, nor does the mention of trade names or commercial products constitute endorsement or recommendation by the Department of the Interior, or the Pennsylvania Historical & Museum Commission.

This program receives Federal financial assistance for identification and protection of historic properties. Under Title VI of the Civil Rights Act of 1964, Section 504 of the Rehabilitation Act of 1973, and the Age Discrimination Act of 1975, as amended, the U.S. Department of the Interior prohibits discrimination on the basis of race, color, national origin, disability or age in its federally assisted programs. If you believe you have been discriminated against in any program, activity, or facility as described above, or if you desire further information, please write to: Office for Equal Opportunity, National Park Service, 1849 C Street NW, Washington, DC 20240.

TABLE OF CONTENTS

If you are reading the Guidelines digitally, this Table of Contents has interactive links. Click any title to go directly to that section. Click the fish symbol on any page to return to the Table of Contents



 CHAPTER 1: INTRODUCTION & PROCEDURES	5
1.1 Purpose of the Guidelines	6
1.2 Design Review Procedures	8
1.3 Preparing Your Application	12
1.4 How to Use the Guidelines	13
 CHAPTER 2: HISTORIC DISTRICTS & PROJECT PLANNING	15
2.1 Levels of Preservation Policy	16
2.2 Benefits of Preservation	19
2.3 Evaluating Impacts	20
2.4 The Secretary of the Interior's Standards	21
2.5 Planning a Project	23
 CHAPTER 3: GUIDELINES FOR EXISTING BUILDINGS	29
3.1 Roofs	30
Dormers	36
Chimneys	38
Skylights	40
Gutters & Downspouts	41
3.2 Exterior Envelope: Wood Siding & Trim	44
3.3 Exterior Envelope: Masonry	49
Foundations	53
3.4 Architectural Metals	54
3.5 Windows	55
3.6 Doors	61
3.7 Porches, Exterior Steps & Stairs	63
3.8 Mechanical & Utility Equipment	65
3.9 Technology & Equipment	70
3.10 Accessory Structures	72
3.11 Fences & Streetscape Features	74
3.12 Commercial Storefronts	77
Signage	79
3.13 Accessibility & Code-Required Work	80
3.14 Relocation & Demolition	82
 CHAPTER 4: GUIDELINES FOR NEW CONSTRUCTION	84
4.1 Additions	85
4.2 New Buildings	88
4.3 New Accessory Buildings	91
 CHAPTER 5: FURTHER RESOURCES	92
5.1 Glossary	93
5.2 Milford's Architectural Styles	96
5.3 Abbreviations	102
5.4 Preservation Incentives	103
5.5 Preservation Resources	104

THIS PAGE LEFT INTENTIONALLY BLANK



CHAPTER 1

INTRODUCTION & PROCEDURES



The Milford Historic District contains a wealth of architectural styles and residential, commercial, and mixed use buildings.

1.1 PURPOSE OF THE GUIDELINES

Recognizing the value of Milford’s historic buildings, the Borough of Milford has adopted an ordinance that designates a historic district (Milford Historic District) to preserve the borough’s historic character and regulates changes to buildings within the district. The borough created a Historical Architectural Review Board (HARB) to conduct design review of proposed changes to historic district buildings, and to advise the Borough Council on approval of these changes.

The purpose of the *Borough of Milford Design Guide* (“the Guidelines”) is to advise the treatment of historic buildings in order to preserve and enhance their unique character. They articulate best practices and encourage compatible changes that protect the character of Milford’s historic district. The Guidelines are intended to assist property owners, residents, contractors, design professionals, local government staff, and members of the HARB in making appropriate decisions about changes to a historic property.

The Guidelines are based on established preservation practice and philosophy, primarily *The Secretary of the Interior’s Standards for the Treatment of Historic Properties*, and Milford’s architectural traditions. Milford’s first *Design Guide* was adopted following the local historic district designation and serves as the foundation for this document. The Guidelines are updated periodically to respond to new treatments, new technologies, and new conditions affecting Milford’s built environment. The Guidelines serve to:

- » help implement the Borough’s Historic District Ordinance;
- » support the work of the HARB and Borough Council as the regulatory authorities responsible for preservation;
- » encourage property owners to use appropriate treatment approaches;
- » establish a framework for determining appropriateness; and to promote predictability in decision-making during the design review process.

Users of the Guidelines will find the following practical information essential to their proposed projects and navigating the HARB review process:

- » Boundaries of the Milford Historic District, where existing or proposed buildings are subject to HARB review ([page 7](#))
 - » Description of the application process and requirements for approval by the HARB ([page 8](#))
 - » Definition of changes to buildings within the historic district that require review by the HARB ([page 9](#))
 - » The criteria used by the HARB to evaluate proposed changes ([page 20](#))
 - » Contact information for HARB members to discuss your project in the planning stages ([Borough Website](#))
 - » HARB Certificate of Appropriateness application form ([Borough Website](#))
-



Milford’s historic buildings and spaces are unique resources that are part of what makes the borough special. The local historic district helps protect them from the future.

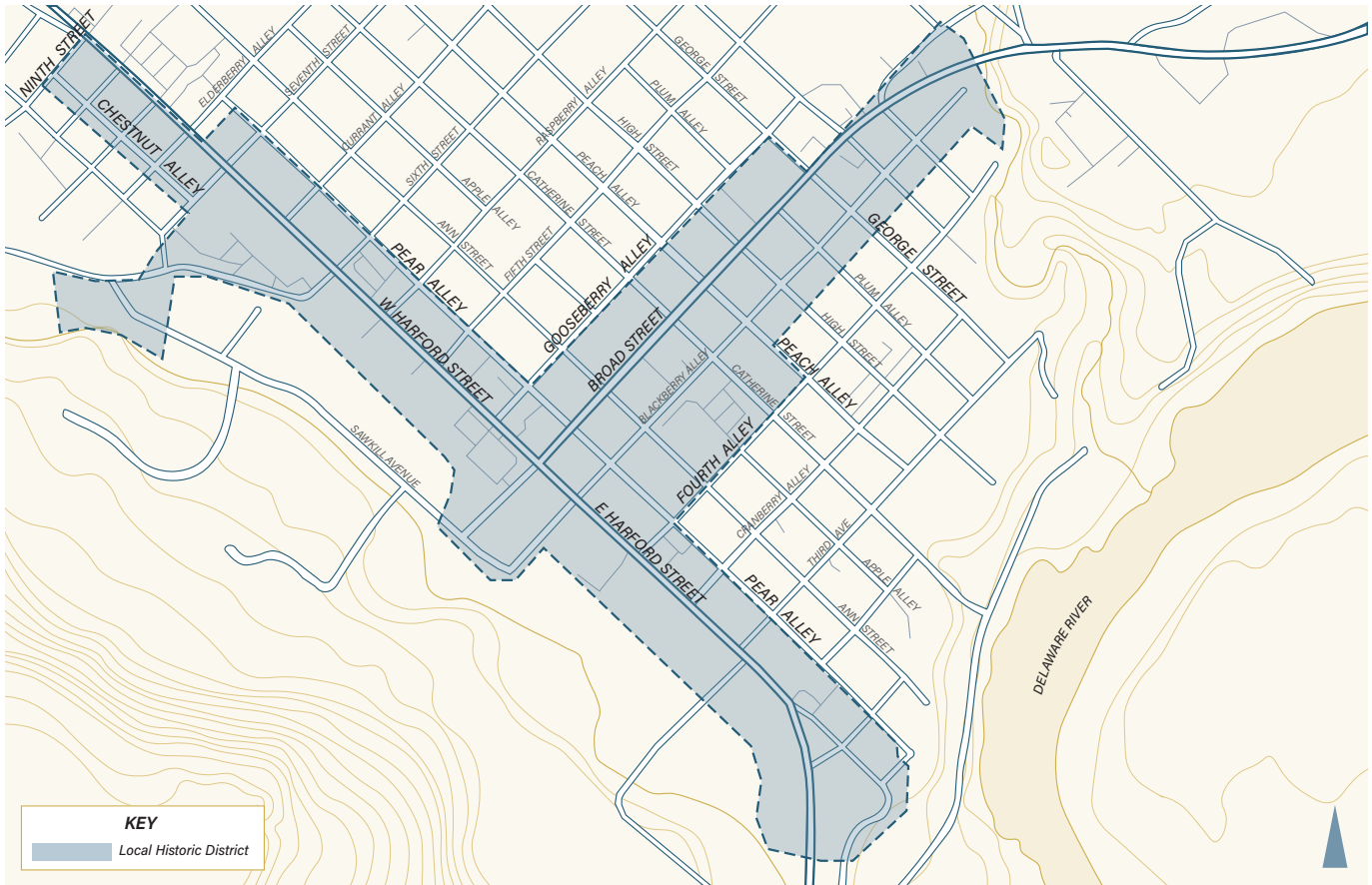

Figure 1. Map of the local Milford Historic District, also known as the Commercial and Limited Commercial District.

The Guidelines do not intend to freeze buildings in time, but to manage change to prevent unnecessary or even unintentional loss of Milford's built heritage. The Guidelines are also not intended to anticipate every possible design scenario. Rather, they establish the framework within which the specific conditions of each proposed project will be reviewed and provide the versatility to develop solutions that are consistent with Milford's preservation goals.

APPLICABILITY

The Guidelines apply to the local Milford Historic District, also known as the Commercial and Limited Commercial Districts. The district will be referred to as the "Milford Historic District" through this document. HARB review applies to all properties within this district.

PRESERVATION TREATMENTS

The Guidelines apply to all buildings, structures, and properties located within the locally designated Milford Historic District. All proposed exterior alterations, additions, new construction, and demolition are subject to the Guidelines and review by the HARB.

Although the Guidelines apply as a regulatory tool only within the historic district, its preservation principles and treatment approaches are relevant to all historic buildings in Milford.

1.2 DESIGN REVIEW PROCEDURES

The HARB has jurisdiction over all changes to the exterior of buildings or structures located in the Milford Historic District, when the changes are visible from a public right-of-way. Approvals are issued in the form of a Certificate of Appropriateness (COA). A COA must be issued before work can begin. This process is administered by Borough Staff, the Historical Architectural Review Board (HARB), and the Borough Council.

This section describes the HARB application and review process.

WHO'S WHO?

"Staff" refers to the Borough Secretary, who fulfills the role of HARB support staff. They are the first point of contact for proposed work. They can provide pre-application guidance, review COA applications for completeness, and facilitate the HARB review process.

The HARB is an advisory board that was created by the Historic District Ordinance. The "HARB" has also historically been known as the "ARB." Board members are volunteers and are appointed by the Borough Council. The HARB reviews COA applications for work within the local historic district, makes recommendations to the Borough Council, and oversees the designation of local historic districts. The HARB holds a public meeting on the second Wednesday of every month.

HARB members have expertise in architecture, historic preservation, construction, law, real estate, planning, and local history. By the Ordinance, members must be qualified to serve on the HARB and collectively have a breadth of expertise and perspective that benefits Milford's local preservation work.

The Borough Council is the regulatory body that officially approves or denies COA applications. They review COA applications and the HARB's recommendations.

PROCEDURE OVERVIEW

Some work does not require review or approval, such as routine maintenance or interior changes. All other work requires review and approval by the HARB and the Borough Council, either through an expedited Administrative Review by Staff and HARB or a full HARB review.

A COA is required even if the proposed work does not require a building permit. Building permits and necessary approvals from other municipal agencies cannot be issued without HARB and Borough Council approval. Work approved under a COA must comply with applicable building code and zoning regulations.

After the COA is issued, if the scope of work changes or new conditions are uncovered during the course of construction, applicants should contact Staff to discuss the changes. These should be documented to maintain compliance with the COA and keep a record of the work that has occurred. Staff and the HARB may inspect work once it is completed to confirm that it follows the issued COA.

Undertaking work without approval can result in project delays and possible violations. Unapproved changes are subject to fines and property owners may be required to correct inappropriate work and restore the building to its prior appearance.

LEVELS OF REVIEW

The HARB has established an Administrative Review procedure to streamline the approval process for property owners. Administrative Review applies to certain types of alterations when that work is consistent with the Guidelines.

Figure 2 ([page 9](#)) illustrates how the levels of review can apply to common types of work. For projects that do not require review, only the types of work shown do not require a COA. Approval depends on compliance with the Guidelines in the following chapters and the specific information provided to HARB as part of an application.

REVIEW CRITERIA

To evaluate the appropriateness of proposed work, the HARB must consider if the work meets these Guidelines, the review criteria included in the Historic Preservation Ordinance, and the Secretary of the Interior's Standards. Refer to additional information beginning on [page 20](#).

DOES MY WORK REQUIRE REVIEW OR APPROVAL?

	COMMON TYPE OF WORK *	REVIEW NOT REQUIRED	ADMINISTRATIVE REVIEW & APPROVAL	HARB REVIEW & APPROVAL
GENERAL	Interior repairs, alterations, or renovations with no exterior change.	✓		
	Repairs or alterations not visible from a public right-of-way (street, alley, public path, etc.).	✓		
	Routine maintenance that does not cause a change in design, material, style, texture, shape, appearance, etc. (e.g. caulk, sealant, repainting existing painted surfaces).	✓		
	Ordinary minor repairs or in-kind replacements that do not cause a change in design, material, style, texture, shape, appearance, etc. and are consistent with the Guidelines.		✓	
	Replace exterior cladding.			✓
	Paint color (Note that HARB does have jurisdiction over permanent material color, like roof shingles).	✓		
ROOFS	Repair or in-kind replacement of historic roofing that matches the original exactly.		✓	
	Replacement of original historic roofing with an alternate material.			✓
	In-kind replacement of non-historic roofing (asphalt-based shingles, roll membranes).		✓	
WINDOWS	Repair of original historic windows.			✓
	In-kind replacement of original historic wood windows that match original exactly, including in material.			✓
	Replacement of historic wood windows with other alternate materials.			✓
	Replacement of non-original vinyl or metal windows with new aluminum-clad wood windows.		✓	
	Installation of new or replacement storm windows (interior or exterior) that are consistent with the Guidelines.		✓	
DOORS	Repair or in-kind replacement of original historic doors that match the original exactly, including in material.			✓
	Replacement of original historic or existing doors with alternate materials.			✓
	Installation of new or replacement storm doors that are consistent with the Guidelines.		✓	
MASONRY	Brick and stone masonry repointing.			✓
	Repairing existing coated masonry or painting or coating exposed masonry to address deterioration.			✓
EQUIPMENT	Installation of window unit air conditioners not visible from main public right-of-way.	✓		
	Installation of through-wall HVAC equipment, or exterior changes caused by interior work.			✓
	Installation of utility meters (e.g., gas, water, electric) in coordination with the public utility agency.		✓	
	Installation of satellite dishes not visible from main public right-of-way.		✓	
	Solar panel installations.			✓
SITE FEATURES	Installation of wood privacy fencing or appropriate alternative material around side and rear yards.			✓
	Replacement of paving materials or installation of new paving materials.	✓		
	Landscaping.	✓		
STOREFRONTS & SIGNS	Repair and restoration of existing storefront materials and windows with treatments that are consistent with the Guidelines.		✓	
	Installation of new signs.		✓	
	Temporary signs	✓		

Figure 2. Levels of Review Chart

* "Common types of work" are provided as examples. It does not show all possible types of work. Only the types of work listed under the category "Review Not Required" do not require a Certificate of Appropriateness.

The steps of HARB review are illustrated in the flowchart below. Additional information about what happens at each step follows on the next page.

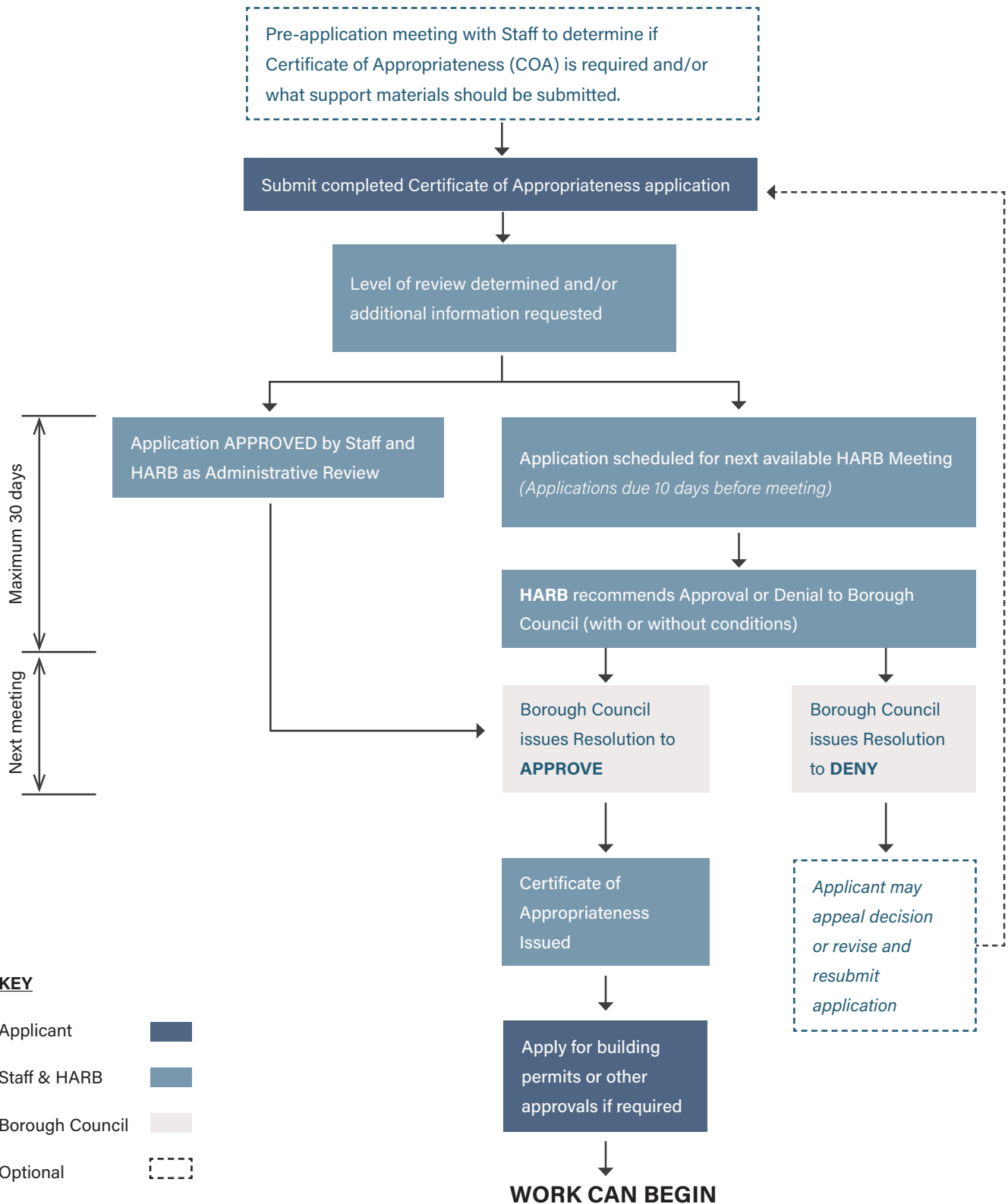

Figure 3. HARB review procedure

HARB REVIEW STEPS

Step 1: Pre-Application Meeting

Applicants are urged to meet with Staff and/or HARB members about proposed work. HARB can advise applicants on visibility of the work, relevant sections of these Guidelines, and necessary application materials. This step is optional but highly encouraged to save time and effort.

Applicants can also request an advisory pre-application discussion with the full HARB to receive feedback. This is considered an informal review and will not result in a recommendation to Borough Council.

Step 2: Submit COA Application

Applicants complete the COA application and submit to Staff, by email, by mail, or in person. Staff will review the submitted application for completeness and request additional information from the applicant as necessary. They will forward the application to HARB members for pre-meeting review. They will determine the appropriate level of review for the proposed work.

Step 3: Administrative Review or Scheduled for HARB Review

If the proposed work meets the criteria for Administrative Review and meets the Guidelines and the Historic District Ordinance criteria, Staff and the HARB can recommended immediate approval by Borough Council.

The HARB and Borough Council are currently developing a review policy for proposed work that is an emergency repair due to an unsafe or hazardous condition. Applicants should contact Staff and HARB for a case-by-case expedited review.

For all other proposed work, the application's review is scheduled for the next available HARB meeting. Applications must be submitted at least 10 days before the meeting to be scheduled. Applicants will be contacted if their application is incomplete and advised what is needed.

Step 4: HARB Meeting

The HARB will review the application at a public meeting. The materials submitted by the applicant will be presented to the HARB. The HARB will evaluate the appropriateness of the proposed work. Applicants and/or design professionals should attend the meeting. Attending the meeting means that questions can be discussed, which may prevent unnecessary delays.

The HARB will make a recommendation to approve or deny the application, and may provide conditions for approval. The

written recommendation and application are then submitted to the Borough Council.

The HARB may postpone or "table" an application for review at the next HARB meeting if the application does not contain enough information for the HARB to make an accurate evaluation. They will recommend what information should be submitted. Staff can assist applicants before the next meeting.

Step 5: Borough Council Meeting

The Borough Council will issue a resolution to approve or to deny the application at the next Borough Council meeting. The Borough Council is responsible for reviewing the HARB's recommendation and the application materials under the same criteria as HARB. If Borough Council issues a resolution to approve, the COA is issued. If the Borough Council issues a resolution to deny, the applicant may appeal the decision, or may revise the application and resubmit it to the HARB.

Step 6: Resolution and COA Issued

The issued resolution and COA will be provided to the applicant. Once the COA is received, applicants can apply for building permits or approvals from other agencies (if required) or begin work.

USEFUL LINKS

To download an application form:
[Certificate of Appropriateness](#) from the Borough Forms webpage.

Milford's [Historic District Ordinance](#), Chapter 167 of the Borough Code.

Milford's [Zoning Ordinance](#), Chapter 312 of the Borough Code.

REMINDERS FOR APPLICANTS

Unsure if proposed work requires approval?
Have questions about what will be considered visible? Confused about what supporting information you should submit about your project?

Contact Staff and HARB about a free pre-application discussion. Contact information can be found on the [Borough's website](#).

1.3 PREPARING YOUR APPLICATION

When planning exterior work at a historic property, prepare and submit applications with plenty of time before you wish to start construction work. Consulting the Guidelines and contacting HARB early in project planning is highly recommended. Preliminary reviews can smooth the design review process and save time and money. When planning a project, it is important to consider impacts of proposed work on both your individual historic building and potential impacts to the surrounding historic district.

The Certificate of Appropriateness application is available online or in person at the Borough Office. This standard application includes basic property information, a description of the proposed project, and supporting materials like photographs and drawings. There is a \$125 fee to apply. Application and support materials can be submitted by email, by mail, or in person.

The application and supporting materials must provide specific, accurate, and thorough information about the proposed work so the HARB can make an informed evaluation. It is important to show the condition and appearance of existing features. It is also important to note whether features are original or are replacements. An application will not be considered complete unless all work items are described and detailed in support materials. The HARB has the authority to request additional information and postpone making a recommendation at the public meeting.

A complete application should include the following items:

- » Completed Certificate of Appropriateness form.
- » Property map or site plan showing the location of the building in the historic district.
- » Current color photographs of the front of the building facing the main right of way.
- » Current color photographs showing details of the proposed area(s) of alteration and existing conditions of the materials and features to be impacted, including documentation of damage or deterioration.
- » Plan, elevation, and detail drawings with dimensions, clearly showing the location, size, appearance, and materials of proposed work. Sketches and drawings prepared by hand can be acceptable. Drawings prepared by an architect or contractor are also acceptable. The level of detail depends on the scope of work.
- » Manufacturer cut sheets or product data for specific components of the project, such as HVAC equipment or new roof shingles.
- » For proposed replacement of original materials, documentation of attempts to repair or assessments of the infeasibility of repair.

WHAT MAKES A GOOD APPLICATION?

- » Information that is specific to the building and the proposed project.
- » Clear presentation of existing conditions and existing materials.
- » Enough information so the HARB can visualize the proposed changes.
- » In the case of historic material replacement, documentation of efforts to repair, restore, or replace in-kind, or of infeasibility of repair.

REMINDERS

- » An applicant will not be required to undertake work beyond their proposed scope, unless a violation has been issued.
- » The presence of a type of material already in the historic district does not guarantee appropriateness. Such elements may be considered “existing non-conforming” or were in place before the historic district was designated.
- » In the design review process, the HARB considers the unique circumstances of each project. Previous approval of a specific type of project in one set of circumstances does not necessarily set a precedent for approval of future projects that may appear to be similar.

1.4 HOW TO USE THE GUIDELINES

First, define your project goals and find **what guidelines** could apply and contribute to an appropriate project development. The document is divided as follows

CHAPTER 1:

INTRODUCTION & PROCEDURES

CHAPTER 2:

HISTORIC DISTRICTS & PROJECT PLANNING

CHAPTER 3:

GUIDELINES FOR EXISTING BUILDINGS

CHAPTER 4:

GUIDELINES FOR NEW CONSTRUCTION

CHAPTER 5:

FURTHER RESOURCES

Information that you will find throughout the Guidelines includes:

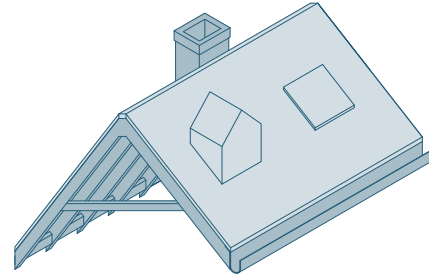

Illustrated terminology and information boxes. When applicable, digital links to relevant published references are included.

Use the following graphic to find what are the chapters or sections you need to review according to what you are planning to do at your property.

	CH 1	CH 2	CH 3	CH 4	CH 5
Renovate or alter a historic property	●	●	●		●
Renovate or alter a non-historic property	●	●	●		●
Add to a historic property	●	●		●	●
Add to a non-historic property	●	●		●	●
Build new construction	●	●		●	●

USEFUL LINKS

[National Park Service Bulletin "How to Apply the National Register Criteria for Evaluation."](#)

Useful Links call-out boxes direct you to additional resources relevant to your project with digital links to published resources.

REMINDER

All exterior work should be reviewed by the HARB before commencing work. When in doubt, contact the Borough Secretary.

Information call-out boxes with reminders about important concepts and information for applicants.

WINDOW GLAZING



The challenge of improving the energy efficiency of buildings with single pane windows and doors ...

Sustainability notes can be identified in call-out boxes illustrated with a leaf. These will give you information on making your project more environmentally friendly with methods that are compatible with historic materials.

In Guidelines Chapter 3 and Chapter 4, the information is organized as follows:

3.1 ROOFS

The roof of a house is an important architectural feature and should be treated as such. Roof forms are character-defining features of architectural styles and roofs contribute to a neighborhood's rhythm and sense of scale. Roofs, architectural features, and drainage systems are also functionally important and should be maintained as an interconnected system for the overall longevity of a building. Materials and details critical to the watertight integrity of roofs include metal flashing and eave trim and should be incorporated in any repair and restoration work undertaken. All efforts should be made to preserve the original roof shape and to properly maintain and replace roof materials as necessary.

Building feature, material, or work type

Design objectives and background information that apply to all guidelines.

MAINTENANCE RECOMMENDATIONS

3.1.1 Inspect roofing systems regularly. Water infiltration through the roof can ultimately damage historic features throughout a building. Identify any broken shingles, exposed sheathing or substrate, damaged or missing flashing, or areas of ponding water for repair. Inspections can be conducted from the ground using binoculars if roof access is difficult. Inspect building interiors for signs of water infiltration. Clear gutters and drainage systems regularly.

3.1.2 Keep historically painted metal roofs well painted to preserve the metal below. Paint acts as a protective layer to prevent the sheet metal from weathering.

DESIGN GUIDELINES

3.1.3 Repair and restore original and historic roofing materials whenever possible. Evaluate the condition and cost of repair of original materials before removing and replacing them. Targeted areas of repair or limited in-kind replacement may be the most effective and low-cost solution.

3.1.4 Repair or replace deteriorated flashing or fasteners with materials that are compatible with the roofing material. Roof problems are often caused by failure of these components rather than the historic roofing material.

3.1.5 Replace historic roofing materials in-kind, especially natural slats, whenever possible if severe deterioration makes a full replacement necessary. Replacement material should match the original in material composition, dimension, shape, profile, color, pattern, exposure, and overall appearance.

3.1.6 If in-kind replacement is not feasible, replace historic roofing materials with alternate materials that resemble the original as closely as possible. Roof replacement should be sensitive to the original appearance. Alternate materials should replicate the shape and dimensional appearance of historic materials. Shaped shingles are appropriate only when replicating existing shingles. Variegated or random widths, variegated colors, or exaggerated shadow lines and overlaps are not appropriate.

3.1.7 Replace non-original roofing materials in-kind or with new materials that are durable and visually unobtrusive. The typical non-original material in Midford is asphalt shingles. Original roofing may have been replaced long ago, yet the replacement materials are not considered historic for the purpose of HARB review and still impacts the overall appearance of the building. If the original material is documented, restoration of the original material (such as natural slats) is appropriate but is not required.

3.1.8 Replace 3-tab asphalt shingles with architectural asphalt shingles on a case-by-case basis. Architectural asphalt shingles are increasingly recommended over 3-tab shingles for durability, and 3-tab shingles are being phased out of production. Appropriate shingles of any type should have rectangular cuts, even aging, consistent exposure, and uniform color.

3.1.9 Preserve architectural features that give the roof its unique and building-specific character—such as domers, cupolas, balustrades, cresting, cornices, brackets, and chimneys. Repair and restore features, and replace in-kind only when necessary.

Design guidelines. Each guideline is expressed as a specific action followed by clarifying information.

They are organized by the governing principles of the Secretary of the Interior's Standards:

- (1) Maintain
- (2) Repair, restore, and reuse
- (3) Replace in-kind
- (4) Replace with accepted alternate materials

DORMER SHAPES

Green check-mark: Retain, repair, and restore existing dormers that are proportional to the roof and match the architectural style.

Red X: Avoid altering the shape and proportion of existing dormers.

Red X: Combining existing dormers into a single larger dormer that is out of scale with the rest of the building is not appropriate. Large dormers are only appropriate if part of the original design.

Photograph 1: Dormers are important architectural features that should be preserved. Dormers are integral parts of both a roof and a decorative scheme.

Photograph 2: Dormers on high-visible side facades are important to the style and rhythm of a building. The original shapes and trim details of historic dormers should be preserved. Original patterns, including different shapes, should be preserved.

Diagrams and photographs to illustrate specific guidelines. Diagrams of appropriate or inappropriate approaches are generalized examples.

Green check-mark indicates appropriate treatment

Red check-mark indicates inappropriate treatment

CHAPTER 2

HISTORIC DISTRICTS & PROJECT PLANNING



Architectural variety adds richness to Milford's built environment. A range of architectural typologies are found throughout the district.

2.1 LEVELS OF PRESERVATION POLICY

POLICY FRAMEWORK

The authority to create and regulate local historic districts comes from Pennsylvania's state-wide enabling legislation known as the Historic District Act (No. 167 of 1961). Each local historic district is certified by the Pennsylvania Historical & Museum Commission (the State Historic Preservation Office).

In December 1999, Milford adopted the Historic District Ordinance, Article 1391 of the Borough Code. The Ordinance allows for the designation of local historic districts and creates the Historical Architectural Review Board (HARB) and its review procedures. The HARB has been known as the "ARB" in local practice but remains a single entity.

DESIGNATED HISTORIC DISTRICTS

Designation of local historic districts is one of the most powerful tools that Milford has to protect its architectural heritage. Stewardship of the natural and built environment has long been at the heart of Milford's history. As the birthplace of the American conservation movement, Milford's valuable natural resources complement its historic built environment. Milford's residents have demonstrated their commitment to the protection of their historic buildings and places by designating a local historic district and by listing a historic district encompassing almost all of the Borough in the National Register of Historic Places (the "National Register").

Being listed in the National Register is not the same as being locally designated as a historic district or individual landmark. Each policy has its own benefits and regulatory process. Local designation offers the most effective protection for historic buildings when compared to listing in the National Register of Historic Districts, because the authority to review potential changes is enforced through a local preservation ordinance.

The difference between the two types of historic district designation is described on the following pages.

HARB'S ROLE

HARB review *is not required* for proposed work at a property that is *only* listed in or eligible for listing in the National Register.

HARB review *is required* for proposed work at a property that is located *inside* the local Milford Historic District.

USEFUL LINKS

[PA SHPO's website of State and Federal Preservation Laws](#), Pennsylvania's Historic District Act enabling municipalities to create HARBs and to designate local historic districts by adopting a local ordinance.

PA SHPO guides about the [National Register Process](#) and [SHPO's Role and Fact Sheets](#)

[PA-SHARE](#), PHMC's online map and cultural resource database. Look up if a property is listed or eligible for listing and find National Register nominations and historic surveys.

National Park Service, [National Register of Historic Places](#)

HISTORIC DISTRICT MAPS

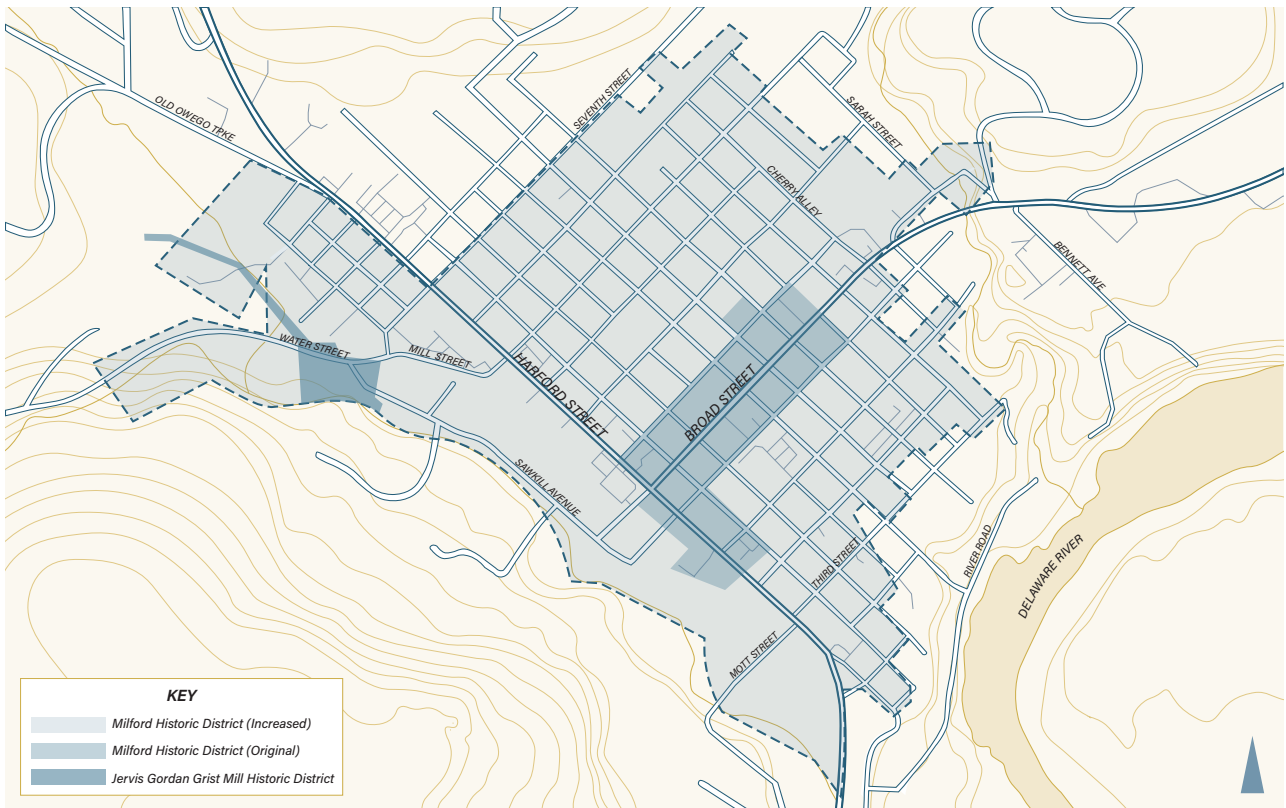

Map of Milford's National Register of Historic Places Historic Districts, including the original boundary and the larger "Increased" boundary. (Source: Borough of Milford, PA-SHARE, Easton Architects)

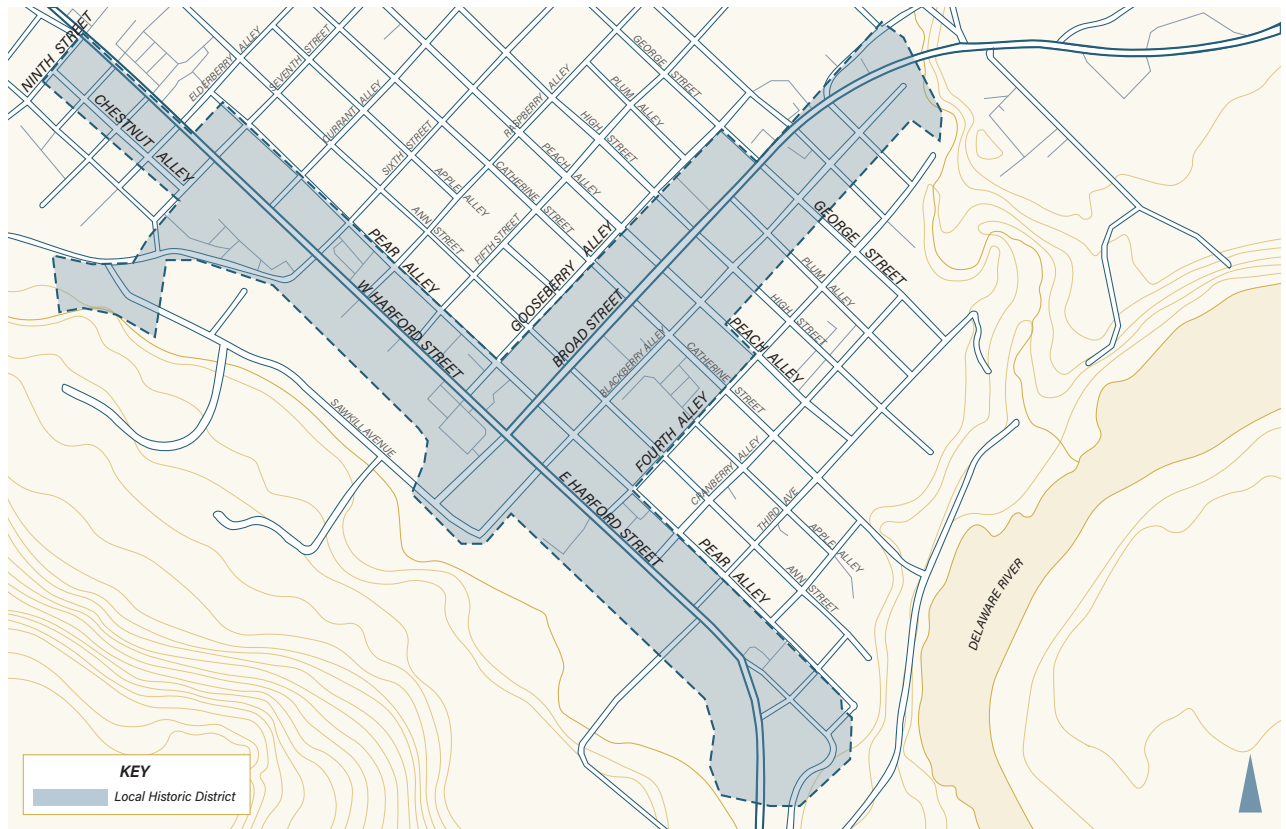

Map of the Milford Historic District, also known as the Commercial and Limited Commercial Districts. The HARB's jurisdiction and these Guidelines apply to properties within this district. (Source: Borough of Milford, PA-SHARE, Easton Architects).

NATIONAL REGISTER OF HISTORIC PLACES

The National Register of Historic Places (National Register) is the nation's most comprehensive inventory of historic resources. The National Register includes public and private buildings, structures, sites, objects, and districts that possess historic, architectural, engineering, archaeological, or cultural significance at the national, state, or local level. It is administered by the National Park Service (NPS). The Pennsylvania Historical & Museum Commission (PHMC) works with NPS and acts as the State Historic Preservation Office (PA SHPO) for the National Register process.

A property is "listed" in the National Register through a nomination process initiated at the local level and coordinated with PA SHPO. The nomination is approved by PA SHPO and then forwarded to NPS. A property can also be determined to be "eligible for listing" in the National Register, meaning that PA SHPO has formally determined that the property meets the significance criteria for listing but a nomination has not yet been prepared.

Benefits of listing in the National Register include:

- » Recognition and education about Milford's unique history.
- » Eligibility for federal and state tax credits, or grants programs.
- » Review of potential adverse effects associated with project with federal or state involvement.

National Register listing does not restrict what can be done with a historic property, or even prevent it from being demolished. Listing in the National Register offers only limited protection for historic properties. Those protections are invoked only when a federal and/or state agency is involved in a project through funding or permitting, or if the property is seeking a tax credit or grant (refer to Chapter 5 for more information).

MILFORD'S LOCAL HISTORIC DISTRICT

Local historic districts are designated for their historic, architectural, and cultural significance and their enduring original character that reflects a municipality's unique history. A district represents a concentration of buildings, structures, and spaces that visually conveys a sense of aesthetic or historical continuity. Buildings within a district may lack individual distinction, yet contribute to a district's collective significance. Over time, districts may have undergone changes that have become part of each district's story.

A historic district's character-defining features can be understood at a building scale and on a street- or neighborhood-scale. Types of character-defining features include:

- » Layout and composition, in street patterns, circulation paths, land uses, streetscape rhythms and setbacks.
- » Visual continuity or patterns in overall building form, appearance, and materials.
- » Interrelationship of buildings, structures, and spaces.
- » Concentrations of buildings exemplifying a certain style, use, or period of time; or conversely, variety of buildings that demonstrate change over time and events or influences that shaped the borough as a whole.

Identification of historic resources is a continuous and collaborative process. Local designation is a key method of recognizing the power of place to communicate history. It offers the most protection for the historic physical fabric of a neighborhood that makes each place distinctive.

Milford currently has a single historic district: the Milford Historic District, also known as the Commercial and Limited Commercial Districts. This district reflects a range of historic resources that have been part of Milford's development: exemplary craftsmanship of 18th and 19th century designers, to an eclectic mix of revival styles echoing national trends in commercial and residential architecture. Despite alterations and demolition in the late 20th century, the district has a cohesive sense of place created by the architecture of individual buildings and the landscape connecting them.

2.2 BENEFITS OF PRESERVATION

Preservation in Milford can play a key role in achieving the borough's planning, economic, social, and environmental goals. Preserving existing buildings, compatible changes, local historic district designations, and regulatory design review all promote the benefits of historic preservation that go beyond aesthetics. Historic preservation enhances community character, fosters a sense of pride and collective responsibility, and has proven to have economic, social, cultural, and environmental benefits.

ECONOMIC BENEFITS

- » Studies in Pennsylvania and around the nation have demonstrated that historic district designation helps stabilize, and even enhance, property values. It promotes reinvestment in local neighborhoods.
- » Historic preservation favors local construction jobs and promotes employment and training for skilled craftspeople.
- » Preservation promotes heritage tourism.
- » Studies of historic neighborhoods demonstrate that preservation of buildings support small businesses and mixed-use activity to accommodate local resident needs.

ENVIRONMENTAL BENEFITS

- » Preservation promotes maintenance of walkable neighborhoods, as historic neighborhoods often developed with pedestrian-oriented plans.
- » Preservation conserves the embodied energy that went into constructing historic buildings and structures already. Therefore, the energy required to fabricate existing lumber, bricks, and other details has already been expended.
- » Keeping historic structures and material in good repair reduces the amount of material that is sent to landfills.
- » Historic buildings are intrinsically "green" with substantially lower environmental impact than new construction. New construction often includes demolition of existing buildings, with construction waste accounting for 25%-30% of landfills, in addition to waste associated with the fabrication of new construction materials.
- » Retrofitting existing buildings or certain elements of a building can achieve similar levels of energy efficiency and performance as a new building. Improvements are often simple and inexpensive, and avoid invasive treatments.

- » The most appropriate materials for the majority of preservation projects are often traditional materials that are more sustainable than non-biodegradable manufactured products such as vinyl and plastics. Historic materials can usually be repaired more easily than modern materials and do not require full replacement, therefore reducing the amount of new material produced.
- » In terms of carbon emissions, avoiding new construction and instead using replacement and maintenance to upkeep existing structures can drastically decrease emissions.

CULTURAL, SOCIAL, AND EDUCATIONAL BENEFITS

- » Preserving historic places promotes cultural and social sustainability by supporting everyday connections between residents and the cultural heritage of the community. Preservation retains the historic buildings that make Milford unique.
- » Preservation of Milford's physical places that played roles in regional, state, and national history protects this history for current and future citizens interested in experiencing this history.
- » Advocacy and education can foster community pride by creating a unique sense of place and local identity, and increasing awareness and appreciation of local history.
- » Repair, restoration, and preservation retains physical teaching tools about local history, local people, and past craft and construction methods.
- » Historic buildings serve as physical spaces to connect with intangible history.
- » Preservation promotes an appreciation of the physical and natural environments.

USEFUL LINKS

[Pennsylvania Historical and Museum Commission, Economic Benefits of Historic Preservation Activities in Pennsylvania \(2011\)](#)

[National Trust for Historic Preservation, Preservation & Economic Resource Center and Preservation & Sustainability Resource Center](#)

2.3 EVALUATING IMPACTS

ORDINANCE CRITERIA

When HARB evaluates the impact of proposed work, they must consider how the changes impact an individual building *and* the surrounding historic district. Per the Ordinance, the HARB must consider the following criteria:

- » Broad historical values representing the cultural, political, economic, or social history of the Borough of Milford.
- » The relationship of the building or structure to historic personages or events.
- » Significant architectural types representative of a certain historical period and a style or method of construction.
- » The effect of the proposed change upon the general historical and architectural nature of the district.
- » The appropriateness of exterior architectural features which can be seen from a public street or way.
- » The general design, arrangement, texture, material of the building or structure and the relation of such factors to similar features of buildings or structures in the district.

EVALUATING SCALE OF IMPACTS

When planning a project, applicants should also consider potential impacts to both the building and district. Impacts can be positive or negative. Defining different scales of potential impact when evaluating appropriateness is beneficial for Staff, the HARB, and applicants alike.

- » **Building scale:** The HARB first considers the impact to the individual building. How does the proposed work change a building feature or material? Is the feature unique to the building or a character-defining feature of its architectural style? Is this building contributing to the local historic district? Buildings with non-original features or materials are permitted to remove those features or make exterior changes to be more in keeping with the district.
- » **Block scale:** The HARB then considers impacts to the surrounding blocks (the rest of the block on either side and the block across the street). Is the building part of a group or pattern that is visible on the block? Do the proposed changes interrupt a pattern or make the historic connection between buildings less apparent? Streetscape patterns can be in materials, ornamentation, design, massing, form, proportion, rhythm, and scale.

- » **District scale:** The HARB finally considers impacts to the historic district. How do the proposed changes impact the historic district as a whole and the reasons for its significance? Is the feature or material rare or distinctive in the district? Would the proposed change contribute positively or negatively to the cumulative effect of changes in the district? What may seem like a small change on one building can lead to a larger impact on the whole district over time.

HIERARCHY OF FAÇADES

Buildings can be understood to have a hierarchy of façades, meaning that certain areas of the building are highly visible and have the most importance, while other sides are less visible and less influential on the overall character. Because most of the buildings in the historic district are surrounded by open space and there are secondary alleys that expose rear façades, almost every part of a building is technically visible.

A hierarchy of façades allows more flexibility in design review and evaluating the scale of potential impacts to historic buildings and historic districts. Proposed alterations at primary and contributing secondary façades will be reviewed more closely than non-contributing secondary façades, because they have a greater potential impact.

- » A primary façade is the “front” of the building, containing the main entrance and character-defining architectural features. Primary façades are visible from the public right-of-way.
- » Contributing secondary façades are highly visible façades that are not the primary façade but are significant to the building’s design. Typical contributing secondary façades are the side of a corner building or the sides of a detached building. These façades are just as visible as the primary façade and may contain character-defining features. Throughout these Guidelines, contributing secondary façades are also referred to as highly-visible façades.
- » Non-contributing secondary façades are considered to be the rear of the building, a façade that is only visible from an alley, side façades that are only partially visible from a public right-of-way or do not influence the overall design, or are not visible.
- » Non-visible façades are façades that cannot be seen by a pedestrian from any public right-of-way. These are not reviewed by HARB.

2.4 THE SECRETARY OF THE INTERIOR'S STANDARDS

CHOOSING A PRESERVATION TREATMENT

The Guidelines are based on *The Secretary of the Interior's Standards for the Treatment of Historic Properties*, commonly known as the Standards. The Standards were adopted as part of the Federal Historic Preservation Tax Credit program in 1977 and are administered by the National Park Service. The Standards provide a consistent philosophical approach to proposed work on historic resources and are the primary tool for evaluation used by federal agencies, state governments, and local government bodies throughout the United States.

Four sets of Standards have been developed to fit specific treatment approaches for historic buildings: Preservation, Rehabilitation, Restoration, and Reconstruction. While they share a similar intent, each treatment has its own guidelines and objectives. Understanding the various treatments is important to help identify the most appropriate approach. The National Park Service's definitions of the four treatments are excerpted below:

Preservation is the act or process of applying measures necessary to sustain the existing form, integrity, and materials of an historic property. Preservation is an appropriate treatment when the objective of the project is to retain the building as it currently exists. Protection, maintenance, and repair are emphasized while replacement is minimized.

Rehabilitation is the act or process of making possible a compatible use for a property through repair, alterations, and additions while preserving those portions or features which convey its historical, cultural, or architectural values. In Rehabilitation, historic building materials and character-defining features are protected and maintained as they are in the Preservation treatment. However, greater latitude is given to replace extensively deteriorated, damaged, or missing features using either the same material or compatible substitute materials. Of the four treatments, only Rehabilitation allows alterations and the construction of a new addition, if necessary for a continuing or new use for the historic building.

Restoration is the act or process of accurately depicting the form, features, and character of a property as it appeared at a particular period of time by means of the removal of features from other periods in its history and reconstruction

of missing features from the restoration period. Restoration is the treatment that should be followed when the expressed goal of the project is to make the building appear as it did at a particular—and at its most significant—time in its history.

Reconstruction is the act or process of depicting, by means of new construction, the form, features, and detailing of a non-surviving site, landscape, building, structure, or object for the purpose of replicating its appearance at a specific period of time and in its historic location.

Of the four treatments, the **Standards for Rehabilitation** offer the most universally applicable guidance to protect historic properties and allow for the most flexibility in project development. For this reason, the Standards for Rehabilitation are ubiquitously used for design review in local historic districts. The Standards for Rehabilitation are also the regulatory standard for the Federal Historic Preservation Tax Incentives program. Refer to the Standards for Rehabilitation on the following page.

APPLICANT RESOURCES

The National Park Service has developed a comprehensive collection of project planning resources. Preservation Briefs, Preservation Tech Notes, Guidelines on Sustainability and Guidelines on Flood Adaptation provide in-depth guidance and “how-to” information that is compliant with the Secretary of the Interior's Standards. Specific documents are referenced throughout these Design Guidelines. *The Standards for the Treatment of Historic Properties* and additional information are available at the [National Park Service's website](#)

THE STANDARDS FOR REHABILITATION

- 1.** A property will be used as it was historically or be given a new use that requires minimal change to its distinctive materials, features, spaces and spatial relationships.
- 2.** The historic character of a property will be retained and preserved. The removal of distinctive materials or alteration of features, spaces and spatial relationships that characterize a property will be avoided.
- 3.** Each property will be recognized as a physical record of its time, place and use. Changes that create a false sense of historical development, such as adding conjectural features or elements from other historic properties, will not be undertaken.
- 4.** Changes to a property that have acquired historic significance in their own right will be retained and preserved.
- 5.** Distinctive materials, features, finishes and construction techniques or examples of craftsmanship that characterize a property will be preserved.
- 6.** Deteriorated historic features will be repaired rather than replaced. Where the severity of deterioration requires replacement of a distinctive feature, the new feature will match the old in design, color, texture and, where possible, materials. Replacement of missing features will be substantiated by documentary and physical evidence.
- 7.** Chemical or physical treatments, if appropriate, will be undertaken using the gentlest means possible. Treatments that cause damage to historic materials will not be used.
- 8.** Archeological resources will be protected and preserved in place. If such resources must be disturbed, mitigation measures will be undertaken.
- 9.** New additions, exterior alterations or related new construction will not destroy historic materials, features and spatial relationships that characterize the property. The new work will be differentiated from the old and will be compatible with the historic materials, features, size, scale and proportion, and massing to protect the integrity of the property and its environment.
- 10.** New additions and adjacent or related new construction will be undertaken in such a manner that, if removed in the future, the essential form and integrity of the historic property and its environment would be unimpaired.

2.5 PLANNING A PROJECT

KEY PRINCIPLES

The Guidelines are based on The Secretary of Interior's Standards for Rehabilitation which encourage the retention of existing historic materials and architectural features whenever possible. When replacement is necessary, new materials should be historically appropriate. New building elements should be designed with architectural compatibility in mind so that the harmonious exterior relationships of a given building or buildings are preserved. Useful guiding principles include:

Maintenance is the first form of preservation. Maintenance and regular inspection of a historic building helps prevent the serious deterioration of historic materials and features, which can lead to invasive and costly repairs in the future. Identifying any issues early allows minor repairs to be effective and keeps potential problems isolated, protecting the historic building for the long term. Common maintenance work includes clearing drainage systems, repainting wood, and trimming nearby plants.

Repair rather than replace. Deteriorated architectural features should be repaired rather than replaced whenever possible. Repair can stabilize existing features and prevent deterioration. Repair with recognized and tested preservation techniques. Common repairs include consolidation, localized piecing-in of the same material, and mortar repointing.

Replace in-kind. If repair proves inadequate, the next level of intervention is in-kind replacement of extensively deteriorated or damaged elements. In-kind means use of the same material, "like-for-like," and exact replication. The replacement material needs to match the old both physically and visually. Replacements must match the original in size, appearance, design, material, color, texture, and configuration. Historic evidence, in the form of physical, photographic, or records should be referenced for accurate replacement.

Replace with compatible materials. If in-kind replacement is not possible because of the specific material or would not address larger scale deterioration, the next intervention is replacement with acceptable alternate materials. New materials must be compatible with surrounding historic materials. Replacements must match the original material or features as closely as possible in all aspects. New materials must be compatible in performance and not cause damage to adjacent original materials. Removal and replacement of historic architectural features is strongly discouraged.

Replacement materials are reviewed based on their ability to replicate historic profiles within the context of the existing condition of that building. Applicants must demonstrate in their application that repair is not technically or economically feasible and their proposed replacement material is consistent with the Guidelines and historic context.

Reconstruct non-surviving building features by drawing upon evidence and existing examples within the district.

Lost features should be reconstructed to restore the building's original appearance without making up new details or creating a false sense of history. The use of traditional materials and finishes is always preferred, although in some instances, substitute materials may be used if they are able to convey the same visual appearance.

Alter or add elements for a new use sensitively. New elements may be introduced to the building if they are needed to ensure its continued use or for an adaptive reuse. Alterations should not radically change, obscure, or destroy character-defining spaces, materials, features, or finishes. Alterations and additions must not impact the surrounding historic district. Alterations and additions should be reversible in the future to the greatest extent possible.

KEY TERMS: SIGNIFICANCE, INTEGRITY & CONDITION

Understanding your property is the best place to begin planning any project at a historic property. Three key factors should be considered to plan a successful project: significance, integrity, and condition.

Significance is simply defined as what makes a property important, on an individual level or as part of a collective. Properties can be significant for their association with important people or events in local, state, or national history, and as representations of architectural design and methods of construction and craftsmanship. Districts can reflect concentrated patterns and themes that extend beyond a specific building. Understanding why a building is individually significant and why it is contributor to its historic district leads to an identification of its important physical features (known as character-defining features) and the time period of that significance.

Integrity is the ability of a building or property to convey its reasons for significance. Seven aspects are used to evaluate integrity, as defined by the National Park Service below. A building or property must retain a majority of these aspects after an alteration for the work to be considered appropriate.

The seven aspects of integrity are:

- » Location is the place where the historic property was constructed or the place where the event occurred.
- » Design is the combination of elements that create the form, plan, space, structure and style of the property.
- » *Setting* is the physical environment of the historic property, inclusive of the landscape and spatial relationships of the buildings.
- » *Materials* are the physical elements that were combined or deposited during a particular period of time and in a particular pattern of configuration to form the historic property.
- » *Workmanship* is the physical evidence of the crafts of a particular culture or people during any given period in history.
- » *Feeling* is the property's expression of the aesthetic or historic sense of a particular period of time.
- » *Association* is the direct link between an important historic event or person and a historic property.

Condition is the physical state of the building and its components. Addressing existing conditions are generally the impetus for proposed work at a historic building. Existing conditions dictate what level of intervention is necessary and how to approach protecting and preserving a building. It is important to remember that poor condition does not equate to a loss of significance or integrity. Conditions allowed to deteriorate over time may lead to the loss of character-defining features and eventually a loss of integrity.

USEFUL LINKS

For additional information about evaluating significance and integrity, see the [National Park Service Bulletin "How to Apply the National Register Criteria for Evaluation."](#)

For additional information about character-defining features, see National Park Service, [Preservation Brief #17: "Architectural Character—Identifying the Visual Aspects of Historic Buildings as an Aid to Preserving their Character"](#) and [Section 5.2, Milford's Architectural Styles](#) in these Guidelines.

QUESTIONS TO CONSIDER

When planning a project, it can be helpful to ask the following questions:

- » How old is the building? Does it have multiple time periods of significance? Were early additions or alterations made during those time periods?
- » Is it in the local Milford Historic District? Exterior work in the local district must be reviewed by HARB. The preservation principles in these Guidelines are relevant to the treatment of historic properties outside the local district, even though HARB review is not required.
- » Is the building individually significant and for what reason(s)? Why was the historic district designated, and how does the building contribute to that significance?
- » What are the building or property's character-defining features? In other words, what physical features convey the building's and/or historic district's significance?
- » Does the building retain integrity? What alterations or additional have already occurred?
- » Why is the project being proposed? What is the desired outcome? What aspects or improvements are required and what are flexible?
- » What treatment approach is the most appropriate: preservation, rehabilitation, restoration, reconstruction? Rehabilitation is usually the most appropriate.
- » What are the short- and long-term costs of the proposed materials? What are the expected lifespans of the proposed materials? Sometimes the traditional materials or custom work required for preservation work are more expensive; however, the costs are usually comparable to non-traditional work, especially when considered in the long term. Historically appropriate materials tend to last longer and do not need to be replaced as often, which has economic and environmental benefits. Appropriate materials preserve the integrity of the building and historic district and may contribute to maintaining high property values.
- » If a project involves full or partial demolition, is demolition truly the last resort? What due diligence assessments prove that rehabilitation is not feasible and which alternatives have been explored?

SUSTAINABLE PRODUCTS AND RESPONSIBLE PRACTICES

Sustainable Practices in Building and Construction

Practicing sustainability in the built environment generally addresses living in harmony with the natural environment, considering the social, environmental and economic impacts of decisions regarding the use of materials, and reducing our footprint through a more efficient use of clean energy, the conservation of water and a reduction in a material intensive lifestyle. Sustainable building practices involve environmentally responsible and resourcefully efficient use of material throughout a building's life cycle. The purpose of these Guidelines is to promote preservation, while encouraging sustainable practices and materials that fit within the context of the district and are compatible with its historic fabric.

Repairing and restoring existing buildings reduces the use of new materials. This creates a corresponding reduction in embodied energy (energy used in the production of materials). Sustainable practices include retrofitting old structures to serve new needs in order to avoid unnecessary demolition and development. Small and low-impact changes to historic buildings can increase their energy efficiency and their longevity without compromising historic character.

Preserving and reusing historic materials whenever possible has clear environmental benefits by avoiding unnecessary production or extraction of new materials.

As a practice, it also takes advantage of the enduring high quality of historic materials. Old growth wood is the best example: old growth wood is dense, strong, and insect-resistant because of the forests' age. New growth wood is grown and harvested much faster so it does not have the longevity of old growth wood. New growth is used in most

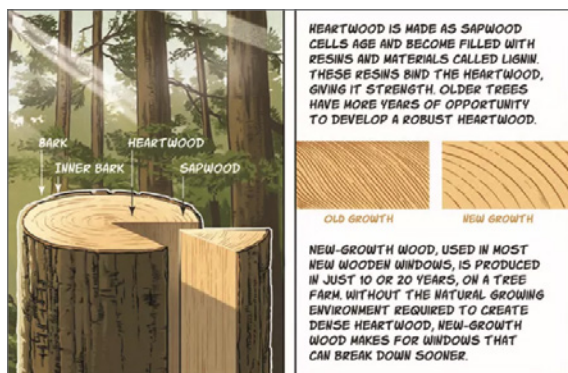

A graphic guide about wood windows created by the National Park Service illustrates the difference in tree ring density between old growth wood and new growth wood, which leads to difference in durability and strength.

building and manufacturing process today out of necessity; however, preserving and reusing historic wood where it already exists keeps higher quality materials intact.

Sustainable Materials & Reuse

For the purposes of these Guidelines, alternative materials can be appropriate for certain categories of building components based on the criteria that they must meet sustainability criteria and used in conjunction with responsible recycling practices for the materials being replaced. The goal is to promote sustainable use practices by supporting the use of materials that come from ecologically friendly manufacturers, limiting the consumption of natural resources to prevent their depletion or the destruction of the environment through the production of materials, and promote products that clearly reflect substantive environmental improvement.

Sustainable building materials typically considered to be 'green' include lumber from forests that have been certified to a third-party forest standard, rapidly renewable plant materials like bamboo and straw, dimension stone, recycled metal, and other products that are non-toxic, reusable, renewable, and/or recyclable. The Environmental Protection Agency (EPA) also suggests using recycled industrial goods, such as coal combustion products, foundry sand, and demolition debris in construction projects. Energy efficient building materials are promoted through energy rebate programs.

Sustainable architecture often incorporates the use of recycled or salvaged materials, such as reclaimed lumber and recycled copper. Reuse of architectural salvage and reclaimed materials is an appropriate and responsible practice that uses traditional materials without consuming new resources. When older buildings are demolished, many materials and components including wood, stone, mantels, hardware, windows, doors, trim and ornamental details may be reclaimed, renewed and reused, immediately reducing



EVALUATING "GREEN" BUILDING MATERIALS

Research about "green" and "healthy" building materials is ongoing and expanding. When deciding whether to use new materials, consider how it is made, how it will perform over time, how it should be maintained, and how it will deteriorate or be reused.

the consumption of new materials. When introducing new materials, it is important to identify those materials that are rapidly replenished within the natural environment.

Sustainable building materials can be found in traditional natural materials procured in renewable and responsible ways and in new products based on recycling other materials. Examples include sustainably harvested wood, sheep wool, hempcrete, panels made from paper flakes, baked earth, rammed earth, clay, vermiculite, flax linen, sisal, seagrass, expanded clay grains, coconut, wood fiber panels, calcium sandstone, locally obtained stone and rock, and bamboo, and non-toxic low-VOC glues and paints.

The sustainability considerations and advantages/disadvantages of certain types of alternative materials and technologies are examined in [Chapter 3: Guidelines for Existing Buildings](#), including:

- » Alternative Exterior Cladding Materials
- » Alternative Decking Materials
- » Alternative Decorative Moldings and Trim
- » Alternative Slate, Cedar, and Asphalt-Based Roofing
- » Alternative Underlayment
- » Alternative Gutter and Leaders

Materials to Avoid

Plastic-based building materials—including vinyl and PVC—are commonly advertised as “maintenance free” and the most affordable option. However, they can have harmful environmental consequences. These impacts are made during their manufacturing and their eventual deterioration and disposal.

Although plastic products may have a lower initial cost, they have shorter life-cycles and require full replacement, which does not save homeowners money in the long term. All building materials requires some amount of inspection, cleaning, and maintenance, so “maintenance free” claims can lead to unintentional neglect and faster deterioration.

The least sustainable building materials also include:

- » VOCs (Volatile Organic Compounds) are organic pollutants in common household products including paint.

- » Petroleum is a key ingredient in the manufacturing of asphalt and rubber roofs.
- » Formaldehyde is found in mass produced building materials and pressed wood products including plywood paneling, MDF and particle board in the bonding adhesives.

SUSTAINABLE BUILDING MATERIALS EXAMPLES



Lumber from certified forests and sustainably harvested wood



Wood fiber panel



Coconut panel



Sheep wool



Seagrass



Sisal



Clay

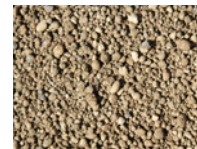

Expanded clay grains



Vermiculite

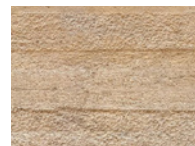

Earth (rammed earth, baked earth)

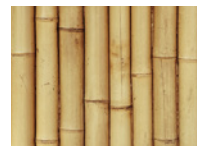

Rapidly renewable local plant materials like bamboo and straw.



Local stone



Hempcrete

SUSTAINABLE RECYCLED MATERIALS



Reclaimed lumber



Recycled metal



Any reclaimed material

INDUSTRY TERMS & STANDARDS

- » A Life Cycle Assessment (LCA) is an evaluation of a product's environmental and health impacts over the product's lifespan from raw material extraction, transportation, manufacturing, use and final disposition or reuse.
- » An Environmental Product Declaration (EPD) is a standardized way of quantifying the environmental impact of raw material acquisition, documenting the energy use and efficiency in the harvesting of the materials as well as the emissions to air, soil, water and waste generation. These impacts include the potential for global warming and ozone depletion.
- » The Health Product Declaration Open Standard (HPD) provides a framework for product manufacturers and their ingredient suppliers to report and disclose information about product and associated health information. The HPD Open Standard is a consensus, stakeholder standard governed by the HPD Collaborative, a not-for-profit member organization, and is increasingly seen in product literature.

If you are proposing a new material in a project, providing these types of assessments can help the HARB evaluate appropriateness through an environmental lens.

PRESERVATION IN A CHANGING CLIMATE

Sustainable building practices and consideration of alternate materials are necessary efforts in the face of climate change. The realities of climate change's impact on historic buildings, neighborhoods, and cities is causing a shift in historic preservation practice. It is an opportunity to re-examine traditional methodologies and find new avenues for compromise and innovation in building practice and material use.

Climate change can impact buildings by increasing the frequency of storms, intensity of winds, and altering ambient humidity and freeze/thaw cycles. Buildings subjected to these forces may deteriorate faster and in different ways than before, creating new preservation challenges.

Adaptation to climate change is an ongoing conversation in preservation practice. These Guidelines acknowledge that how to respond to environmental changes while protecting historic resources remains a debate. The recommendations and alternatives presented throughout the document are based on best practices and encourage the use of sustainable and responsible materials whenever possible.

USEFUL LINKS

For more information about National Park Service strategies that comply with the Standards for Rehabilitation, see the [National Park Service's Illustrated Guidelines on Sustainability for Rehabilitating Historic Buildings](#) and the [Guidelines on Flood Adaptation for Rehabilitation Historic Buildings](#).

THIS PAGE LEFT INTENTIONALLY BLANK



CHAPTER 3

GUIDELINES FOR EXISTING BUILDINGS



Commercial buildings contribute a great deal to the atmosphere of Milford's historic district. The Dimmick Inn remains a well-preserved commercial building anchoring the intersection of the district's two main thoroughfares.

3.1 ROOFS

The roof of a house is an important architectural feature and should be treated as such. Roof forms are character-defining features of architectural styles and roofs contribute to a neighborhood's rhythm and sense of scale. Roofs, architectural features, and drainage systems are also functionally important and should be maintained as an interconnected system for the overall longevity of a building. Materials and details critical to the watertight integrity of roofs include metal flashing and eave trim and should be incorporated in any repair and restoration work undertaken. All efforts should be made to preserve the original roof shape and to properly maintain and replace roof materials as necessary.

MAINTENANCE RECOMMENDATIONS

3.1.1 Inspect roofing systems regularly. Water infiltration through the roof can ultimately damage historic features throughout a building. Identify any broken shingles, exposed sheathing or substrate, damaged or missing flashing, or areas of ponding water for repair. Inspections can be conducted from the ground using binoculars if roof access is difficult. Inspect building interiors for signs of water infiltration. Clear gutters and drainage systems regularly.

3.1.2 Keep historically painted metal roofs well painted to preserve the metal below. Paint acts as a protective layer to prevent the sheet metal from weathering.

DESIGN GUIDELINES

3.1.3 Repair and restore original and historic roofing materials. Evaluate the condition and cost of repair of original materials before removing and replacing them. Targeted areas of repair or limited in-kind replacement may be the most effective and low-cost solution.

3.1.4 Repair or replace deteriorated flashing or fasteners with materials that are compatible with the roofing material. Roof problems are often caused by failure of these components rather than the historic roofing material.

3.1.5 Replace historic roofing materials in-kind, especially natural slate, whenever possible if severe deterioration makes a full replacement necessary. Replacement material should match the original in material composition, dimension, shape, profile, color, pattern, exposure, and overall appearance.

3.1.6 If in-kind replacement is not technically feasible based on the material, replace historic roofing materials with alternate materials that resemble the original as closely as possible. Roof replacement should be sensitive to the original appearance. Alternate materials should replicate the shape

and dimensional appearance of historic materials. Shaped shingles are appropriate only when replicating existing shingles. Variegated or random widths, variegated colors, or exaggerated shadow lines and overlaps are not appropriate.

3.1.7 Replace non-original roofing materials in-kind or with new materials that are durable and visually unobtrusive. The typical non-original material in Milford is asphalt shingle. Original roofing may have been replaced long ago, yet the replacement materials are not considered historic for the purpose of HARB review and still impact the overall appearance of the building. If the original material is documented, restoration of the original material (such as natural slate) is appropriate but is not required.

3.1.8 Replace 3-tab asphalt shingles with architectural asphalt shingles on a case-by-case basis. Architectural asphalt shingles are increasingly recommended over 3-tab shingles for durability, and 3-tab shingles are being phased out of production. Appropriate shingles of any type should have rectangular cuts, even spacing, consistent exposure, and uniform color.

3.1.9 Preserve architectural features that give the roof its unique and building-specific character—such as dormers, cupolas, balustrades, cresting, cornices, brackets, and chimneys. Repair and restore features, and replace in-kind only when necessary.

ROOF SHAPES

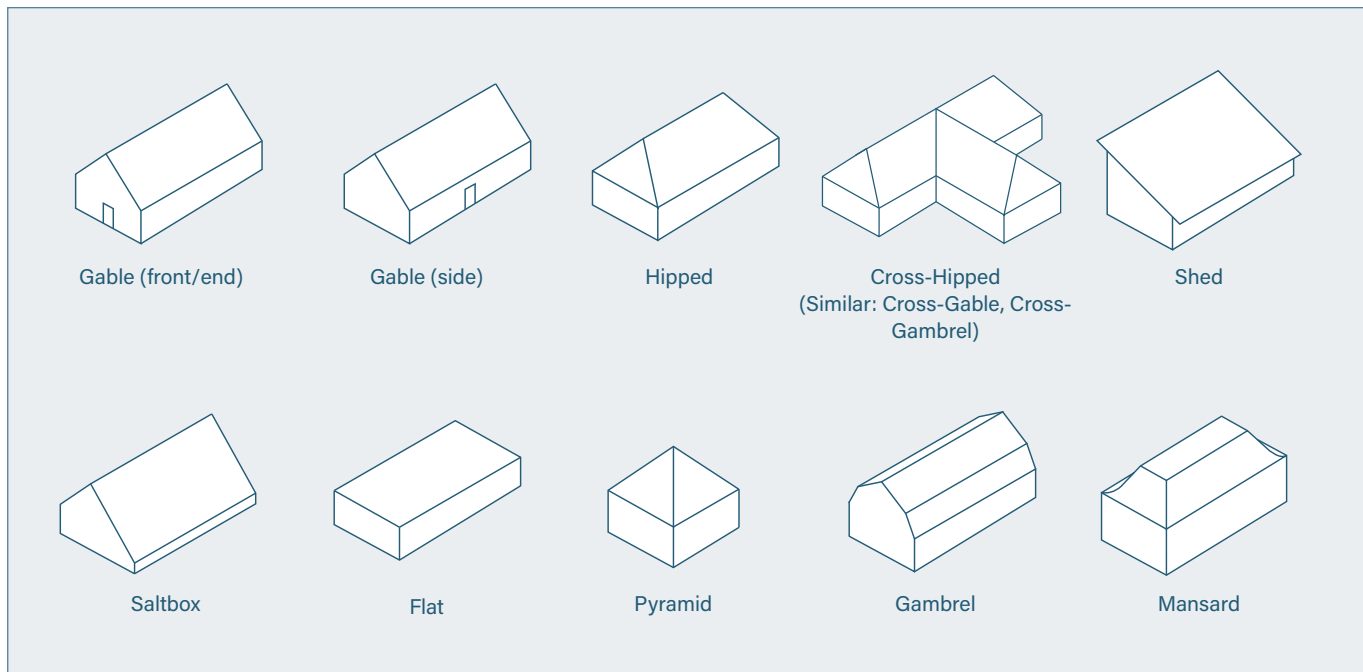

ROOF ANATOMY

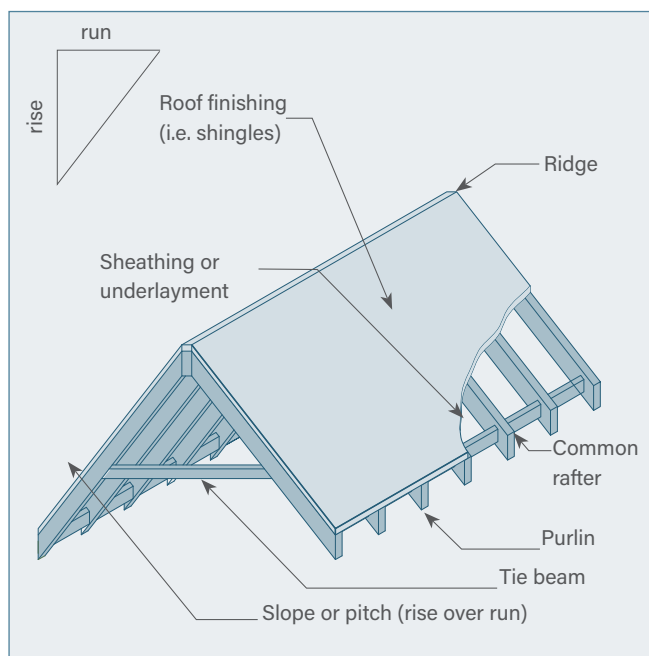

ROOF FEATURES

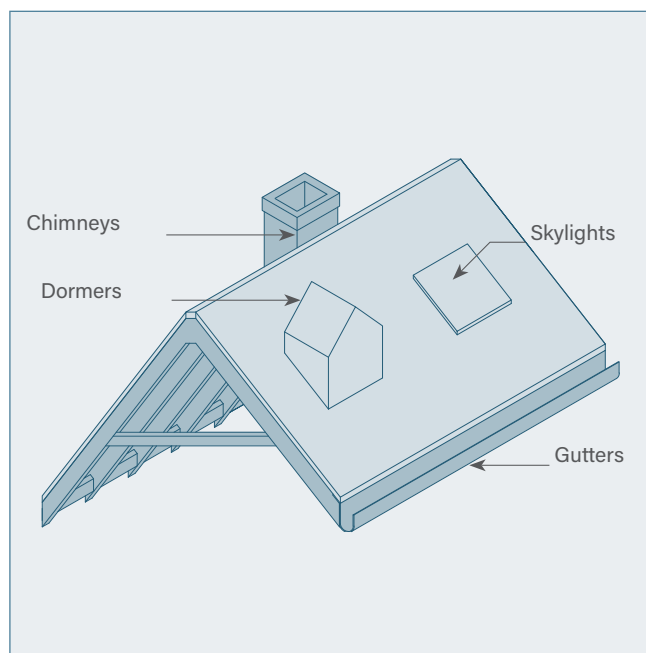

TYPICAL HISTORIC MATERIALS

Historic roofing materials in Milford are wood shingles, natural slate shingles, and metal. However, if an uncommon material exists on a specific building or was a original documented feature, it can be considered historic.

Wood shingles were used in early American buildings and certain architectural styles through the 19th century. Red cedar and white oak are common species used historically and today. Because of fire hazards, most original wood shingle roofs have been replaced with metal or asphalt-based shingles.

Slate is a natural, durable stone with the ability to be split into thin tiles of uniform thickness to be used in roofing applications in a variety of sizes and configurations. Quarrying slate was a key industry in Pennsylvania in the 19th century, which meant that slate as a building material was more accessible and more affordable. The color variation inherent in the natural stone formation along with the texture gives character to the building material. Slate occurs naturally in different colors: grey, blue, purple, green, and red. In Milford, grey slate prevails. Slate can be cut into shaped shingles to create decorative patterns across a roof slope. Slate has proven over time to be extremely durable and its lifespan varies for different regions. Pennsylvania slate has proven to range from 60 to 200 years, depending on the type, and 100 years is typical. Vermont and New York slate lasts around 125 years, Virginia slate can last around 150-175 years, and many original quarries remain active. With a slate roof, issues are usually caused by fastener failure (nails, hangers) or improper installation rather than the slate shingles themselves.

Metal roofs are composed of flat sheet metal fastened with either flat seams or standing seams. Historic sheet metals included copper, tin, tin-plated iron or steel, and terne plate (steel with an alloy coating of lead and tin) painted red or green. Whether or not to paint metal depends on the type of metal. Most sheet metal roofs should be painted to prevent weathering. Copper should not be painted and should be allowed develop its natural protective patina (green exterior layer).

Each historic roofing materials is visually distinctive, and if well-maintained and monitored can last many decades. Historic roofs in the historic district may have undergone one or several replacement campaigns over time. Certain “modern” materials have been used for many decades, such as asphalt shingles. From a historic preservation perspective, such materials are still considered alternate replacements rather than historic when they would not have been available at the time of a building’s construction.

TYPICAL ALTERNATE MATERIALS

Alternate materials that are designed to have minimal visual impact may be acceptable if they do not detract from the architectural character of the building. Alternate materials sometimes offer a more affordable option to natural materials when a roof replacement is necessary. However, alternate materials generally have a shorter life cycle and will have to be replaced more often, and some products are equally costly. Sustainable roofing products and technology are rapidly evolving to respond to the demand for environmentally responsible products. Technological advancements continue to make new products available. Climate change is also causing wind and storm resistance to be a key concern. Adaptation and resiliency is an evolving perspective through which to evaluate appropriateness of non-traditional materials. The following recommendations reflect known performance characteristics and shall be adapted as new information becomes available. The Guidelines do not endorse any products or manufacturer; references are provided for information purposes only for comparative alternatives.



Alternative Slate Roofing

One of the primary benefits of natural slate is its density, and its weight offers protection as an exterior cladding and roofing material. The material weight adds to the purchase cost as well as installation cost. Alternative materials and methods have been developed to provide options for installing true slate with lighter weights as well as composite materials that give a realistic resemblance to slate while being man-made products.

Alternate natural slate methods can be appropriate. SlateTec patented true slate roofing systems utilize a heavy duty interlayment method under the slate that reduces the slate overlap which in turn reduces the number of slates required to cover and protect more area. The reduced amount of slate reduces the overall cost of the roofing system.

Nu-lok slate roofing systems are based on technology that places the slate tiles edge to edge on a grid supported by battens with a channel system to drain water effectively. This system reduces the amount of slate by up to 40%, thus reducing material costs and roof weight. Additionally, this system increases the energy efficiency of the building through the use of the batten system which allows for natural ventilation under the slate, keeping the roof cooler.

Porcelain roof tile offers a slate-look roofing tile made with recycled and reclaimed materials, has no VOCs (volatile organic compounds), is weather resistant, algae and water resistant, is lighter than slate, is color fast as it carries the same properties as porcelain, and is low maintenance.

Synthetic slate is a category of alternative slate shingles, also known as engineered or composite slate, made from blends of plastics, fibers, and rubber. These products are often made from recycled materials. They are also lighter than natural slate. Synthetic slate products mimic the thickness, size, shape, texture, and color of natural slate. Because they have a thicker profile than asphalt-based shingles and can match original shingle shapes more closely, they are a common replacement material for natural slate and may be an appropriate alternative on a case-by-case basis.

Rubber shingles are inherently petroleum-based products, although they consist primarily of recycled material. Rubber requires substantial additives as it naturally breaks down under exposure to UV light. Rubber has a low factor of rigidity resulting in a very low wind uplift rating. Aesthetically, the rubber shingles do not compare to slate roofs in profile, texture or color and are an inappropriate alternative.

Alternative Cedar Roofing

Traditional cedar shingles are made from old-growth western cedar. Although it is easy to produce cedar shingles, the harvesting of old-growth cedar is neither simple nor sustainable, and old-growth cedar is no longer commercially available due to cutting restrictions. Old-growth cedar roofing was once a long-lasting roofing solution; however, the cedar being used in roofing today is not mature enough to offer the resin development that leads to a 50-year life span. Additionally, environmental issues arise from the unsustainable foresting practices that produce cedar shakes and shingles.

Engineered composite polymer products remain the most environmentally responsible, durable, and reasonably priced alternative to cedar and asphalt. Composite shakes are easier to install and closely resemble the look and feel of old-growth cedar, offering an appropriate alternative.

Porcelain roof tile can also be manufactured with a wood-shake appearance and texture.

Alternative wood shingles are only recommended where wood shingle roofs exist or once existed. Restoration from a non-historic material to a synthetic wood shingle must be supported by physical or historic documentation.

Alternative Asphalt-Based Roofing

One of the most popular conventional roofing materials, asphalt-based roofing, continues to be a rapidly evolving technology with developing more durable sustainable replacements. Generally, high-quality and durable products should be used.

Composite shingles are common replacement materials in the form of 3-tab shingles and architectural shingles. Asphalt became increasingly popular in the '70s and '80s across North America when fiberglass-based shingles were introduced to replace asbestos paper-based asphalt. Asphalt shingles are made of glass fibers (most common) or cellulous fibers saturated and coated with asphalt and surfaced with ceramic-coated mineral granules. Asphalt often becomes the default substitute material for slate and cedar shake roofs due to economic factors.

Asphalt roofs lack the distinctive aesthetic and durability of natural slate. Issues related to granule loss, cracking, curling, and cupping are a constant concern over the roof's lifespan, as is exposure to high winds and exposure to UV light and other climatic conditions. The lifespan of asphalt shingles has significantly reduced since the introduction of fiberglass-

based shingles, and most asphalt roofs will need to be replaced after 10-15 years, making them quite costly over the life of a building.

It also bears mentioning that the fiberglass used in asphalt shingles is bonded with a formaldehyde resin, a highly adhesive but toxic material combined with petroleum-based asphalt resulting in a non-sustainable building material. However, asphalt shingles can be recycled and used for asphalt paving adhering to responsible recycling practices.

The use of high-quality asphalt shingle roofing systems may be considered appropriate alternates depending on the configuration and appearance of the shingles, especially on structures with simple roof configurations.

“Architectural” asphalt shingles are a laminated fiberglass asphalt product. There is a range of commercially available products called “architectural shingles.” These vary in size, shape, color, and dimensional appearance. Products in a single color (typically black or gray), or using a color that matches the color of original slate, are acceptable. Products with even shingle exposures and rectangular cuts are typically acceptable to be consistent with the appearance of historic roofs. Architectural shingles are thicker, provide higher wind resistance, and have longer lifespans than 3-tab shingles.

3-tab shingles are another type of single-layer fiberglass asphalt product. 3-tab shingles became popular because they are low profile and have minimal visual impact once they are installed. Compared to architectural shingles, 3-tab roofs are designed in a single layer and have a flatter appearance with little separation between each shingle. 3-tab shingles are usually the lowest cost alternative and have the shortest lifespan. This product is being phased out by manufacturers and many contractors discourage its use because of durability concerns.

Alternative Roof Underlayment

The underlayment on roofs is typically asphalt-based, which breaks down relatively quickly. Replacing this layer is necessary to keep moisture out of the building’s interior. Synthetic roof underlayment offers an alternative that weighs less and withstands the wear and tear of an exterior environment. Synthetic roof underlayment uses polymer that comes from recycled scrap materials. It also eliminates VOCs from the underlayment.

SHINGLE SHAPES

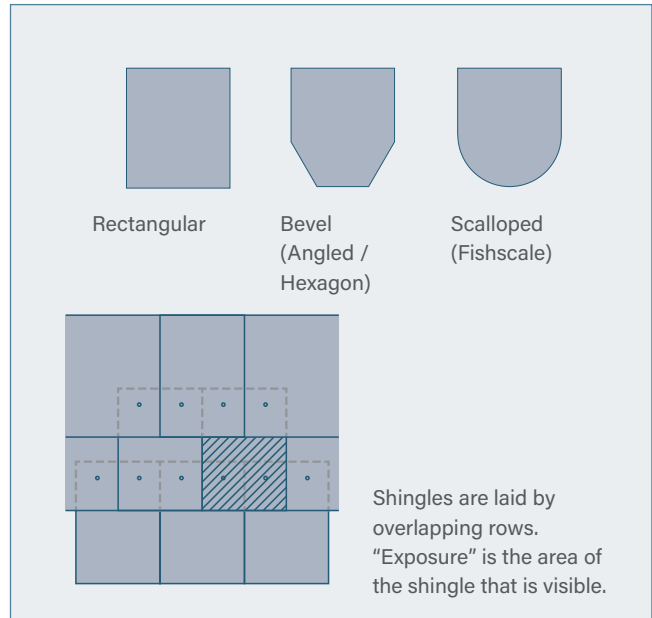

REPLACEMENT SHINGLE TYPES

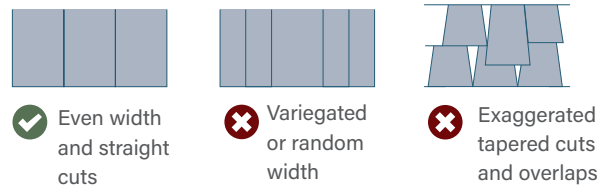

SLATE REPLACEMENT CONFIGURATIONS

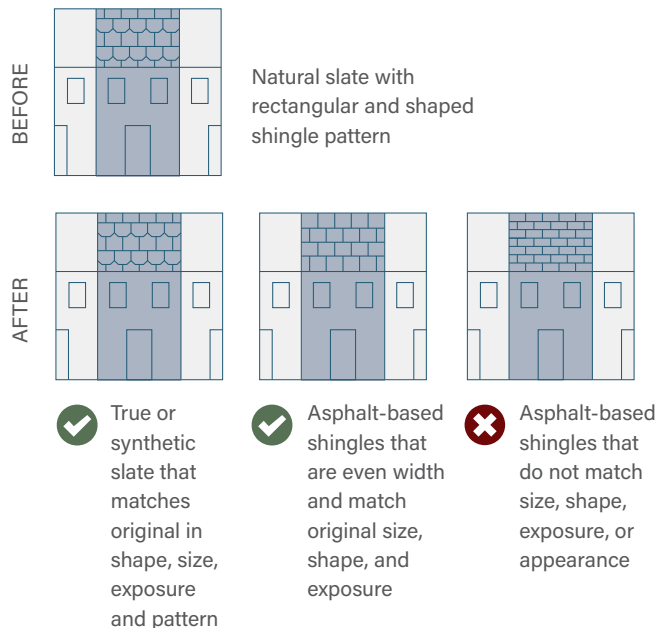

ENERGY EFFICIENCY NOTE

When looking to improve a building's energy efficiency and reduce heating and cooling costs, many people jump to window replacement. However, numerous energy studies show that most energy loss occurs at the roof. Insulating the interior of roofs or attic floors is an effective way to reduce air movement. Rigid polyurethane foam insulation is an appropriate common material. Space for air flow between the underside of the roof and the insulation should be left to protect roof materials from deteriorating. Insulating attic floors are also appropriate and avoids potential impacts to the roof structure and cladding. Exterior roof insulation changes the visual appearance of a roof and is not appropriate; only flat non-visible roofs may be appropriate exterior locations.

The best first step in planning energy efficiency upgrades is to conduct an energy audit. An energy audit analyzes the building's thermal performance. It identifies if energy loss is occurring and where—which means homeowners can upgrade the priority areas first and can avoid making unnecessary changes to historic materials. Learn more about energy audits and insulation in the National Park Service's [online Weatherization guide](#).

Sustainable roof systems, such as green roofs and cool roofs, can provide energy benefits while having low impact to historic materials. Such roof systems are considered compatible if they are not visible from a public right-of-way. The most important factors when considering a green or cool roof is the increased structural load and potential moisture infiltration. A structural assessment should confirm that the roof structure can adequately support the new roof materials.

USEFUL LINKS

National Park Service, [Preservation Brief #4 "Roofing for Historic Buildings"](#)



Slate shingles are common and prominent features often seen on mansard roofs. Different shaped shingles were often used to create decorative patterns.



Even the rear façade of Forest Hall showcases a combination of roof types, dormers, and chimneys that contributes to the historic material integrity of the district.

REMINDER FOR APPLICANTS

Appropriate replacement shingles should have straight cuts, consistent exposure, minimal thickness or 3-dimensionality, and be a solid single color. Shaped shingles are only appropriate when replicating original shingle patterns. In-kind replacement of historic materials is always more appropriate than alternate materials.

Roof Features: Dormers

The form, location, and ornamental detail of dormers contribute to the overall architectural design of the building and should be preserved. Dormers can range from simple to highly ornamented features. The rhythm of dormers on a primary façade and the proportion of dormers to the rest of the roof can have a significant visual impact. Historic dormers in Milford are typically wood-framed, use the same roof materials as the main roof, have sidewalls clad with slate or wood siding to match the exterior walls, and repeat the trim details or decorative schemes used throughout the building.

MAINTENANCE RECOMMENDATIONS

3.1.10 Inspect dormer roofs regularly with general roof inspections. Water infiltration through dormers can ultimately damage the roof structure and historic features throughout a building. Identify any broken shingles, exposed sheathing or substrate, damaged or missing flashing especially at the intersections with the main roof, or areas of ponding water for repair. Inspections can be conducted from the ground using binoculars if roof access is difficult. Inspect interiors for signs of water infiltration.

DESIGN GUIDELINES

3.1.11 Preserve existing dormers in form, materials, and design. Retain the dormer's form and structure, roof shape and pitch, roof and sidewall materials, cladding and ornamentation on the front face, and windows. Retain the historic number and spacing of dormers across a façade or a roof slope. Dormers often reflect the bays or symmetry of a primary façade.

3.1.12 Repair and restore existing dormers whenever possible rather than replace or remove. Repairs may include wood cladding or trim repairs, roof cladding or sheathing repairs, flashing replacement, and reinforcement of interior structural members.

3.1.13 Ensure that flashing remains intact at junctions with the primary roof. Consider adding drip edges (typically copper) at dormer roofs to shed water and protect wood trim.

3.1.14 Repair and restore historic dormer windows whenever possible.

3.1.15 Replace dormers with in-kind materials if severe deterioration has occurred or the roof structure has been damaged. Consult with a professional structural engineer to determine the necessary extent of repairs or replacement with the goal to limit the amount of historic fabric removed.

3.1.16 Avoid altering dormer shapes or roof pitches. It is not appropriate to enlarge dormers or combine existing dormers into one or more larger dormers. Original dormer shapes and details, including differences in shape, should be preserved.

3.1.17 Avoid removing historic dormers if they are original or compatible with the overall design of the building and added during a building's period of significance.

3.1.18 Consider restoration of existing dormers that were inappropriately altered in the past. These dormers can detract from a building's historic character, such as those where decorative trim was removed or those that were enlarged to dominate the primary façade. Consider restoration of original dormers that were removed. Restoration shall be based on documentary evidence like photographs or architectural drawings.

Refer to [Chapter 4: Guidelines for New Construction](#) for guidelines related to new dormers.

DORMER SHAPES

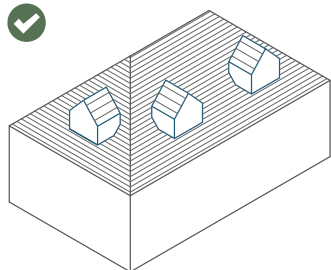
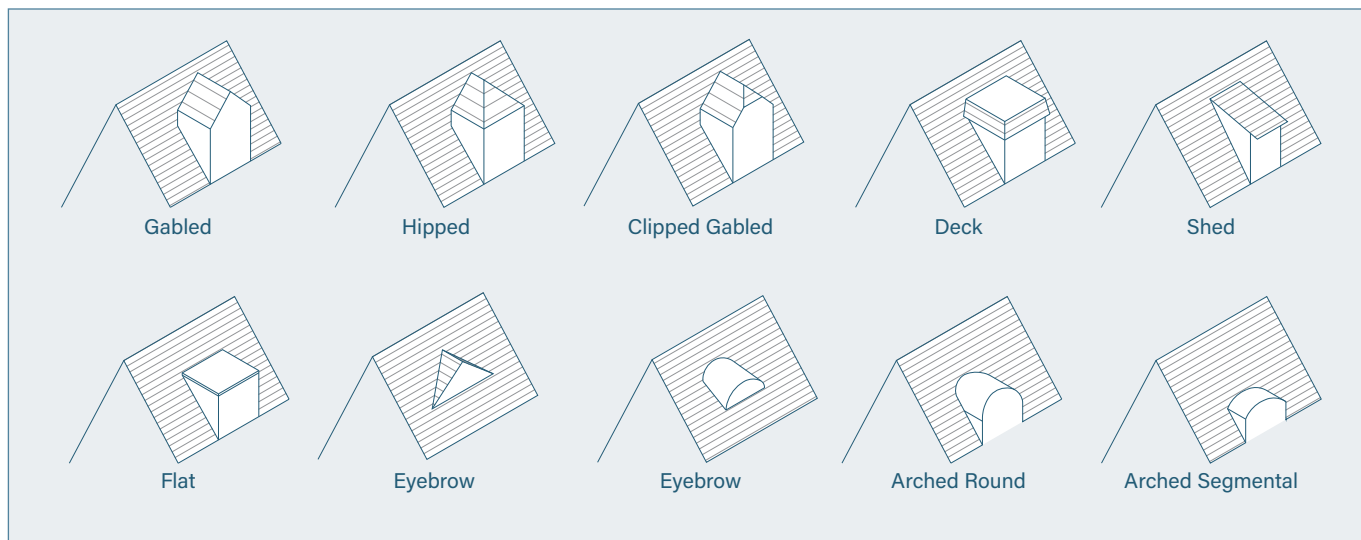

Retain, repair, and restore existing dormers that are proportional to the roof and match the architectural style.

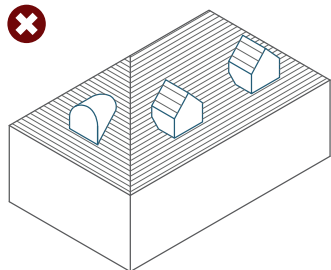

Avoid altering the shape and proportion of existing dormers.

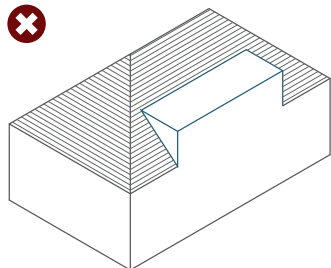

Combining existing dormers into a single larger dormer that is out of scale with the rest of the building is not appropriate. Large dormers are only appropriate if part of the original design.



Dormers are important architectural features that should be preserved. Dormers are integral parts of both a roof and a decorative scheme.



Dormers on high-visible side façades are important to the style and rhythm of a building. The original shapes and trim details of historic dormers should be preserved. Original patterns, including different shapes, should be preserved.

Roof Features: Chimneys

Chimneys are distinctive architectural features that contribute to the visual character of the historic district and are character-defining. Most chimneys in Milford are made of exposed brick or masonry and match the style of the building. The location, size, and appearance of chimneys should be maintained. Whether still functional or purely decorative, chimneys contribute to the visual character and dynamic roof line of the historic district and should be preserved.

MAINTENANCE RECOMMENDATIONS

3.1.19 Maintain and retain existing chimneys. Inspect chimneys for signs of deterioration: cracks in masonry units, mortar, or an applied coating; mortar loss and receding joints; spalling masonry or loss of surface layers; and displacement. Inspections can be conducted from the ground using binoculars if roof access is difficult.

3.1.20 Stabilize chimneys if they are leaning or masonry appears displaced. Due to the age of many chimneys in Milford, slight leaning may have occurred long ago and is no longer an active condition. Consult a design professional or contractor to evaluate the risk and appropriate intervention. Stabilization can take the form of simple metal bracing that should be concealed from the public right-of-way as much as possible.

DESIGN GUIDELINES

3.1.21 Repair and restore historic chimneys. Repoint mortar joints with a compatible and historically appropriate mortar that matches the original in composition, strength, hardness, and color.

3.1.22 Rebuild chimneys if necessary to address structural concerns. Disassemble the masonry, carefully salvage and store the masonry units, and rebuild to the original profile and dimensions.

3.1.23 Repair and restore existing stucco or cementitious coatings to protect the masonry below. Although removal of coatings may be desirable to restore the appearance of the chimney, removal is likely to be costly and potentially harmful to the brick. The brick may be in such a deteriorated state that it cannot be repaired which will require face brick replacement or reconstruction of the chimney.

3.1.24 Retain and repair historic masonry and terra cotta chimney caps and terra cotta. Replace in-kind if repair is infeasible. Replacement with a low profile copper chimney cap may also be appropriate.

3.1.25 Avoid shortening or removing chimneys. Altering a chimney can detract from the roof appearance and the overall architectural style. Chimneys that are no longer operable should be capped and retained in place.

3.1.26 Avoid painting, sealing, or adding new stucco or cementitious coatings to historically exposed brick masonry.

Refer to [Chapter 3.3 Exterior Envelope: Masonry](#) for information about historic mortar composition, bonding patterns, repointing, and masonry coatings.

CHIMNEY TYPES

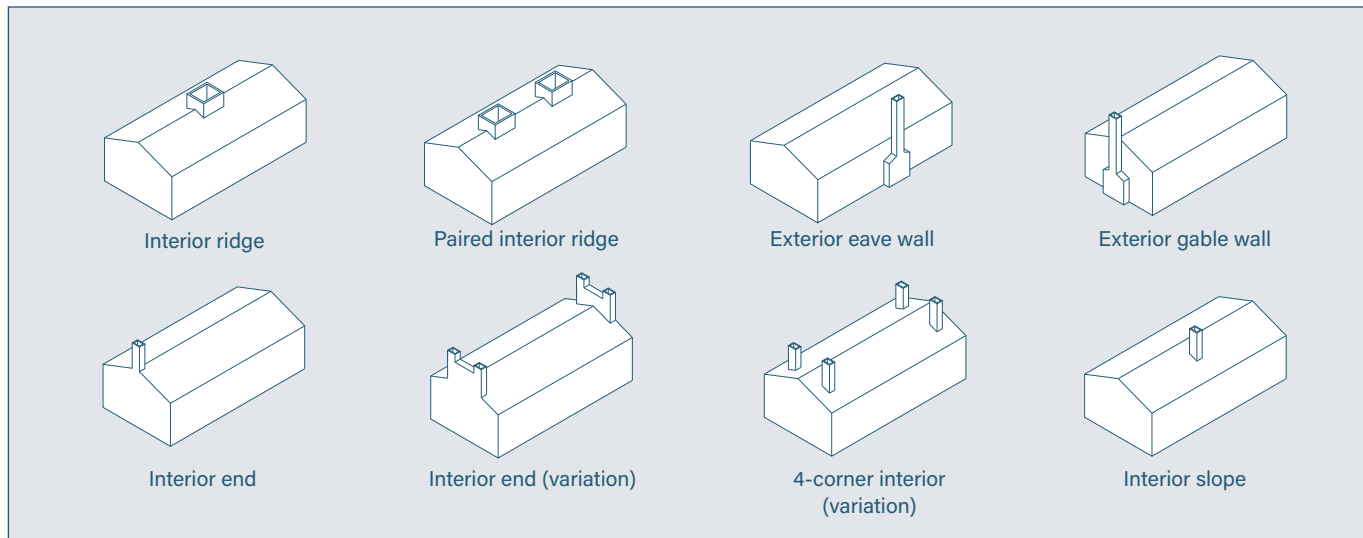

Some buildings styles feature symmetrical interior chimneys, creating distinctive rooflines in a district.



Chimneys can contribute to a building's overall proportion, visual rhythm, and material continuity.



Prominent chimneys located at the center of a house are common features of Milford homes..



Chimneys with decorative brickwork or stonework are distinctive and should be preserved.

Roof Features: Skylights

Skylights are not a common original feature of Milford’s historic buildings. Most skylights are later alterations used to bring light to an occupied upper floor. Adding skylights can be a major change to the appearance of a roof and the overall building. The original roof form and appearance should be preserved over the addition of skylights.

MAINTENANCE RECOMMENDATIONS

3.1.27 Maintain and repair existing skylights, including glazing and flashing. Inspect for water leaks in interior spaces.

DESIGN GUIDELINES

3.1.28 Repair and restore existing skylights. Seal and waterproof all connections where the skylight meets the roof.

3.1.29 Replace existing skylights if repairs cannot address the deterioration and the skylights are no longer watertight. Depending on the appearance and historic nature of the skylight, an in-kind replacement may be appropriate. For non-historic or inappropriate existing skylights, a new design that is compatible with the historic roof should be pursued.

3.1.30 Select appropriate, low profile designs for new skylights or replacement skylights. Skylights should be minimally visible from the public right-of-way. Avoid skylights that read as roof windows and bubble skylights.

3.1.31 Avoid installing new skylights where none originally existed and where they are incongruous with the architectural style. Avoid adding skylights to primary façade roof slopes to protect the historic appearance of the building. If the homeowner can establish that a particular skylight is appropriate to the architectural style of the building, addition of a new skylight may be acceptable.

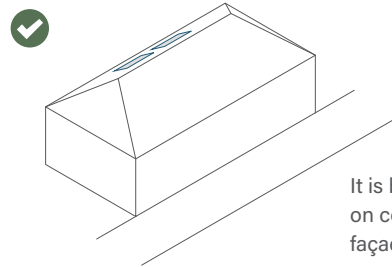

It is best to locate skylights on completely non-visible façades.

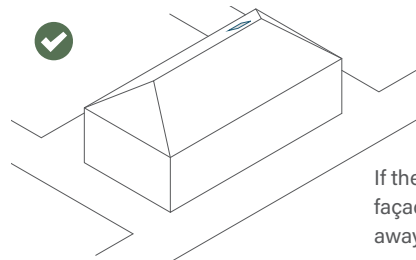

If there are no non-visible façades, locate skylights as far away from the primary street as possible.

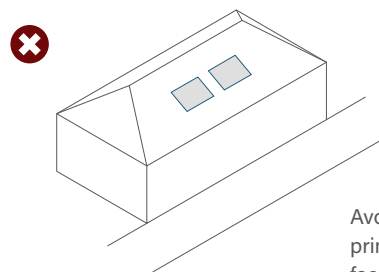

Avoid locating skylights on primary or highly visible façades.

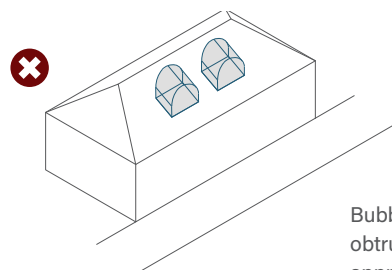

Bubble skylights or visually obtrusive skylights are not appropriate.

Roof Features: Gutters & Downspouts

Gutters and downspouts serve essential functions in preserving historic buildings by collecting and distributing water away from the building. They are integral parts of a roofing systems and should be maintained and designed with the overall roof form and materials in mind. Gutter profiles and shapes can indicate a period of construction. Maintenance of drainage systems is one of the most important steps in proactively preserving historic buildings.

MAINTENANCE RECOMMENDATIONS

3.1.32 Maintain and retain historic gutters whenever possible. Inspect and clean gutters, downspouts, scuppers, and all other drainage components regularly to remove debris and keep drainage systems in good working condition.

3.1.33 Ensure proper drainage away from the building at grade level. Excess moisture can cause deterioration of foundations and wall bases. This can be achieved with inconspicuous leaders or using stone landings with a channel to direct water.

DESIGN GUIDELINES

3.1.34 Repair and restore historic wood and built-in gutters. Paint wood gutters as a protective layer for the wood substrate. Maintaining paint will preserve the functionality and longevity of historic wood gutters. Inspect metal flashing that typically lines a wood box gutter and repair or replace in-kind.

3.1.35 Replicate the original construction method of a historic gutter when replacement is necessary due to severe deterioration. For example, box gutters integrated with eave moldings are a specific design choice to hide the gutter system and demonstrate historic construction methods that should be preserved.

3.1.36 Replace existing hanging gutters (attached below the roof slope edge and typically shaped as a half-round or molded profile) in-kind or install new hanging gutters as necessary. Half-round gutters are appropriate for a historic building as a low visual impact option. Molded profile gutters, also known as K-style gutters, may be appropriate only on a case-by-case basis as an in-kind replacement.

3.1.37 Replace existing downspouts, scuppers, collection boxes, and other drainage elements in-kind. Downspouts

are available with round and rectangular profiles. Smooth surfaces are encouraged over corrugated texture. In the case of decorative scuppers, replicate the profile and details as closely as possible.

3.1.38 Install new downspouts in locations that are sensitive to the architecture of the building and will be minimally visible. Run downspouts at secondary façades and corners. It is not appropriate to run downspouts in the middle of a façade. Retain existing moldings, eave profiles, and gable returns.

3.1.39 Paint or treat new and existing gutters and downspouts to blend in with the building exterior. Matching the existing building trim is usually the most appropriate color selection, especially in a two- or three-color scheme. Copper and terne-coated stainless steel gutters and downspouts may be left unpainted, as they weather naturally and develop a patina.

3.1.40 Replace gutters and downspouts in-kind. If in-kind replacement is not feasible because of the material, consider alternate materials to address site-specific conditions, such as original materials that have demonstrated repeating patterns of deterioration. Alternate material should match the original in profile, appearance, and finish.

3.1.41 Avoid vinyl gutters due to poor durability in low temperatures and non-historic appearance.

ALTERNATIVE GUTTER AND LEADER MATERIALS

Traditionally gutters and leaders did not exist on early American buildings. Advancements in building technology responding to different climates prompted the introduction of water-capturing appurtenances as an architectural element that served more function than form.

Wood built-in gutters are now commonly lined with copper on the interior or must be repainted often. Preserve wood gutters by keeping wood surfaces well-painted and maintaining any metal lining. Although historically appropriate, replacement wood gutters can be less durable compared to metal.

The best conductors of water are metals, with copper being the best followed by terne-coated metal, aluminum, and steel as useful alternatives. **Copper** is incredibly durable and is exceptional in its ability to withstand the elements, corrosion, rust and more. In considering life cycle costs, copper is by far the least expensive gutter installation available.

Aluminum is an incredibly versatile metal that offers affordability, durability, and corrosion/rust resistance. Though it is more easily damaged than other materials like copper or galvanized steel, it can withstand the elements and last for decades when well maintained. Aluminum is lightweight and available in a wide range of colors or paintable to seamlessly blend in with the adjacent building materials. Extruded aluminum gutters are thicker than bent aluminum gutters and have higher load capacities, and can be made with historically appropriate profiles. These are typically appropriate alternatives.

Galvanized steel is made from steel dipped into a hot solution containing zinc that prevents corrosion and rust. Galvanized steel is much stronger than aluminum and copper but will rust over time.

Galvalume is a metal coating, which is made from a combination of silicon, aluminum, and zinc. Much like galvanizing steel, the Galvalume coating protects the steel from oxidation. For this reason, Galvalume gutters tend to last much longer than their standard steel counterparts.

Metal gutters are less susceptible to ultraviolet light exposure than materials like fiberglass, vinyl and plastics. Metal gutters are incredibly strong and able to withstand the most extreme elements. For reasons of durability and performance, metal gutters are appropriate materials. To be aesthetically appropriate, metal gutters should be paintable, with the exception of copper which is best left untreated.

Fiberglass is a glass fiber reinforced plastic; other common names include glass-reinforced plastic (GRP) and glass-fiber reinforced plastic (GFRP). The manufacture of fiberglass products involves extrusion of the glass medium (fibers or ground glass) bonded with chemicals to form a shaped profile.

Advantages of fiberglass include overall strength and stiffness; ability to be molded into customizable shapes, fire resistant, relatively low maintenance, and good insulation characteristics and performance. Its strength and thinness compared to wood gutters allows for increased capacity with little change to the overall gutter dimension, making it a popular choice to manage rainfall and climate change adaptations. Fiberglass gutters are commercially available and can be made in custom profiles based on the existing gutter or moldings. They can be paintable and can be aesthetically comparable to traditional materials.

The disadvantage of fiberglass is it deteriorates over time due to exposure, particularly UV degradation resulting in cracking, brittleness, fading and discoloration. Constant exposure to UV light causes a weakening of the glass fibers resulting in particles becoming airborne. This requires recoating approximately every 5 years. The breakdown of the outer layer(s) impacts the performance and appearance of the material. Fiberglass is not recyclable thus its use is not recommended as a sustainable practice.

Fiberglass gutters may be an appropriate alternative based on the issues being addressed by the proposed replacement; applicants should consider the balance between aesthetics, durability, and life-cycle sustainability.

Vinyl and plastic gutters should be avoided as a non-sustainable plastic-based material that performs poorly in cold environments, has a short lifespan, and is visually detrimental to historic character. These are not appropriate alternative materials.



Example of comparative capacity of historic and alternate gutters for adapting gutters to environmental conditions.

*Images courtesy of Cambridge MA Historical Commission.



INCREASING GUTTER & DOWNSPOUT CAPACITY

The preferred preservation treatments for drainage systems are to repair and replace in-kind. However, existing systems may be undersized for increased amounts of rainfall resulting from climate change, causing overflows and potential damage to historic buildings. In some cases, it may be appropriate to increase the size and capacity of gutters, downspouts, and similar drainage components. For example, a downspout's diameter could be increased instead of adding a new downspout.

Increasing the diameter of the outlet connector between the gutter and downspout can improve functionality without impacting the visual character. Small changes are appropriate and effective adaptations.

Depending on the level of deterioration, it may be appropriate to replace wood gutters with metal or fiberglass gutters that mimic the original design but have increased capacity.

TYPICAL COMPONENTS OF GUTTERS

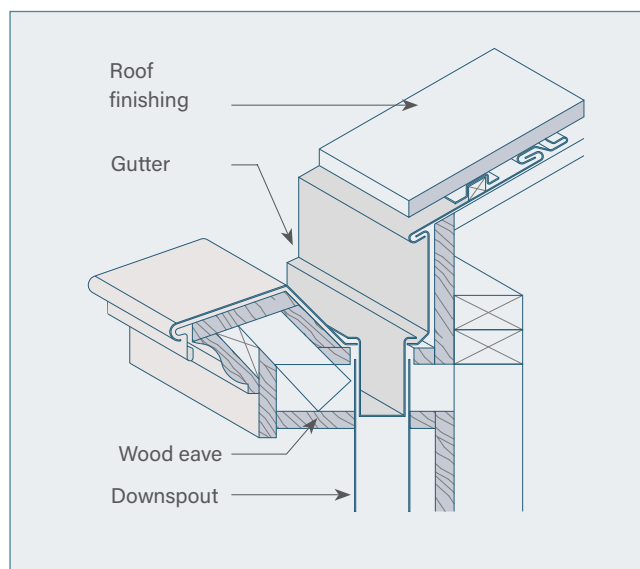
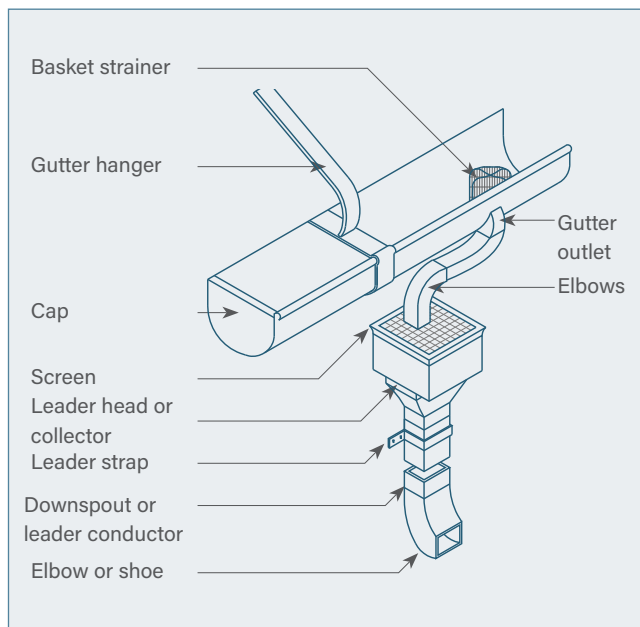

Built-in gutters are built as part of the wooden eave detail of a roof rather than attached to the fascia.



An example of a painted gutter and downspout in appropriate location to blend into the existing building.

3.2 EXTERIOR ENVELOPE: WOOD SIDING & TRIM

The exterior wood elements of Milford's historic properties contribute to the historic district's architectural character and visual variety. Maintaining and repairing existing materials should always be the first approach. If repair is not possible due to the severity of deterioration, in-kind materials should match the old as closely as possible. Exterior wood in Milford is used for decorative trim, cornices, dormer windows, window sills and lintels, and exterior wall cladding. Historic wood elements should be retained and preserved.

MAINTENANCE RECOMMENDATIONS

3.2.1 Clean exterior surfaces periodically using the gentlest methods possible. Avoid using high pressure power washing and any abrasive cleaning or stripping methods that can damage the historic wood siding and detailing. Conduct cleaning tests in a small, non-visible area of the building to determine the most appropriate method.

3.2.2 Provide proper drainage so that water does not stand on flat, horizontal surfaces or accumulate in decorative features. Inspecting a building after rain is an easy way to detect standing water or drainage blocks.

3.2.3 Keep wood surfaces well-painted. Retain paint layers that help protect wood from moisture, biological growth, and ultraviolet light. Paint removal should be considered only where there is paint surface deterioration and as part of an overall maintenance program which involves repainting or applying other appropriate protective coatings.

3.2.4 Stabilize deteriorated wood prior to undertaking the appropriate preservation work. Reestablish weather resistance and structural integrity if there are holes in the material, through bracing or temporary covers, while minimizing disturbance of existing fabric.

3.2.5 Maintain original wood siding and trim. Wood shingles are only appropriate for exterior cladding if they were used as an original siding material such as on some Queen Anne buildings.

DESIGN GUIDELINES

3.2.6 Repair and restore original wood siding and cladding materials whenever possible. Preservation of historic materials is encouraged to retain visual character, protect the building's structure and interior, and prolong the life of the building.

3.2.7 Repair and restore wood trim features such as cornices, brackets, window moldings, and doorway

pediments. Trim work is an essential part of a building's architectural character. Unique features of a building should be preserved.

3.2.8 Repair historic wood features by patching, piecing-in (also known as dutchman) repairs, consolidating or otherwise reinforcing the wood using recognized preservation methods. Repair may also include limited replacement in-kind of extensively deteriorated or missing parts of wood features.

3.2.9 Replace deteriorated materials in-kind if repair is technically infeasible. New materials should duplicate the original as closely as possible in material composition, size, profile, shape, pattern, and appearance. If historic wood siding or trim was an identifiable or visually distinctive species, it is recommended that the same species be used for the replacement. Recommended species are clear cedar or redwood. White pine is generally not recommended unless quarter-sawn, which has greater durability.

3.2.10 If a house is to be re-clapboarded, align the clapboards to match the window heads and sills. Clapboards should be applied smooth side exposed.

3.2.11 If in-kind replacement is not technically feasible based on the material, alternate materials may be acceptable on a case-by-case basis depending on the location, type, and visibility of proposed replacements and if addressing site-specific deterioration issues. All materials should be painted.

3.2.12 Avoid installation of aluminum, vinyl, or other synthetic materials. Neither installation over wood siding nor replacement of wood siding is appropriate with these materials. These alternate materials are not appropriate for historic properties because of their visual impact and because their installation can trap moisture and cause deterioration problems.

WOOD SIDING TYPES

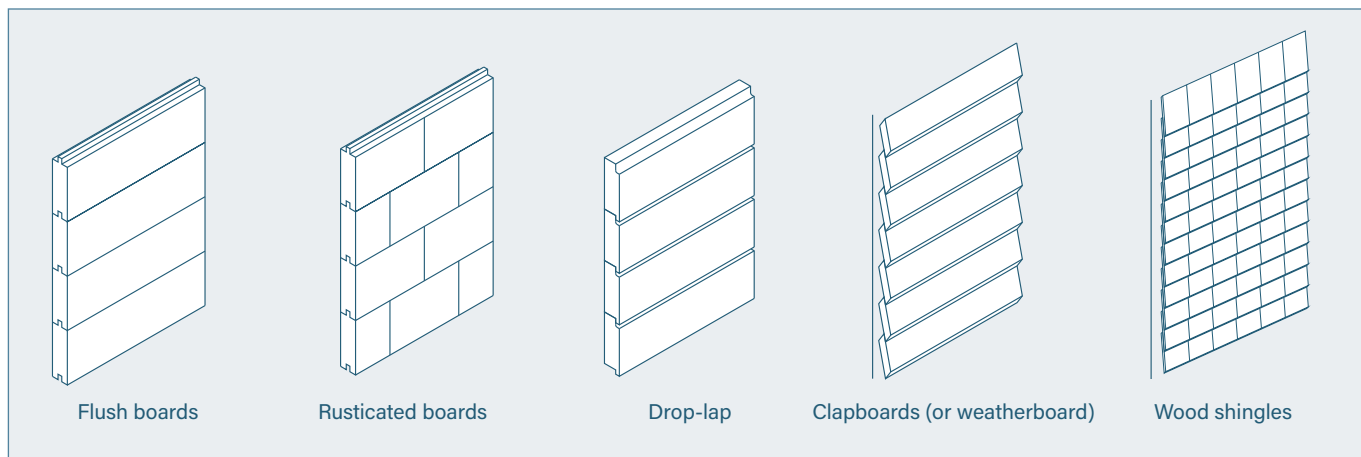

3.2.13 Consider removal of existing aluminum, vinyl, or synthetic sidings and replacement with wood or approved alternate materials. Historic materials sometimes remain intact below this type of siding and can be restored. In-kind replacement of existing non-historic siding that was in place before the historic district was designated may be allowed in some cases. Consult with HARB during early project planning stages. Provide photographs or documentation of existing conditions and wall materials below non-historic siding to help determine the appropriate treatment.

PAINTING GUIDELINES

3.2.14 Inspect painted wood thoroughly to determine whether repainting is necessary or if cleaning is all that is required.

3.2.15 Remove peeling, flaking, or failing paint to the next sound layer of paint using the gentlest methods possible to protect the integrity of the historic wood surface, and using lead-safe practices as necessary. Acceptable methods for paint removal include hand-scraping and hand-sanding, and when necessary, mild chemical strippers or gentle micro-abrasion methods. Sand blasting, high pressure power washing, and mechanical grinders should not be used to remove paint from any surface. Evaluate the condition of the wood surface (the substrate) and address any moisture infiltration and deterioration issues before priming and repainting.

3.2.16 Paint once the surface is clean and dry. Use a paint type that will adhere properly to the wood surface, such as oil-based or alkyd-acrylic paints. Marine grade paints are recommended because they perform well over longer periods of time in wet climates.

3.2.17 Use a brush method to ensure paint coats are even and have the minimum thickness for a durable coating (usually specified by the manufacturer). Spray-painting is generally not recommended because it is harder to control, creates thinner and less durable layers, and has potential environmental effects.



An example of well-preserved wood siding and decorative elements.

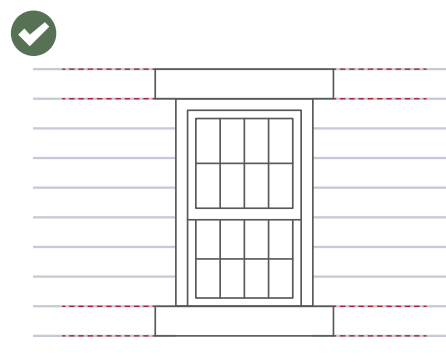

Align clapboards to original window heads and sills when repairing or replacing.



TYPES OF PAINT

Oil-based paint has long been the standard for wood and is still recommended by many manufacturers and contractors. It bonds well with wood, creates a durable coating that protects the wood, and retains color.

An alkyd-acrylic paint is an appropriate alternative. Its base is composed of both oil and water. This paint has similar properties as strictly oil-based with lower VOC, which is an environmental advantage. Like oil-based paint it is a flexible coating that will accommodate wood swelling and shrinking.

A third option is water-based acrylic urethane paint. It has a high concentration of resin which creates durability and performs well in marine air, and has acceptably low range VOC.

Paint technology is constantly evolving to create low-VOC and more environmentally-friendly products that perform as well as oil-based. Environmental policies are also changing and may impact the types of exterior paints accepted in the future.

Properties to look for in an appropriate paint are compatibility with a wood substrates, flexibility, and durability in exterior UV light.

USEFUL LINKS

For information about lead paint and historic buildings, see:

National Park Service, [Preservation Brief #37: Appropriate Methods for Reducing Lead-Paint Hazards in Historic Housing](#).

PHMC: [Guidance for Lead Based Paint Abatement in Historic Preservation Projects](#).

TYPICAL ALTERNATE MATERIALS

Typical alternatives to wood for exterior cladding and decorative moldings are fiber cement siding, composite wood, and fiberglass. These materials are commercially available but should be considered with caution. Applicants should demonstrate that repair and in-kind wood replacement options have been assessed.

Fiber cement siding also known as Hardie Board or Hardie Plank offers a similar appearance to wood siding, although weighs more and may carry a higher cost to install due to the product size and weight. The benefits of fiber cement board products include high durability, pest resistance, fire resistance and is highly customizable in achieving a similar aesthetic as the original material in color, dimension and texture. If deemed appropriate as a localized replacement for a case-by-case durability issue, smooth textures should be used rather than faux wood graining.

Fiber cement siding is made from natural and sustainable raw materials including wood fiber, water, cement and sand. It has no asbestos, glass fibers or formaldehyde, making it a safe building material for sustainable building practices.



Painted wood siding is the most historically appropriate material for repairs and replacement. Siding with faux wood texture is not appropriate.



Wood siding and detailed wood pediment should be preserved.



Different types of wood siding at a primary façade and secondary façades is common, like this house with singles (left) and clapboards (right).

ALTERNATE MATERIALS CONTINUED

Composite wood is an engineered, polymer-based mixture of wood fibers and plastic. Composite products have the advantage of being able to be molded into shaped profiles and are durable, lightweight, and dimensionally stable. They can be painted to match adjacent building materials and need relatively low maintenance. Composite wood products can be appropriate on a limited basis for elements such as upper story trim, roof balustrades, or rear details.

Fiberglass is a glass fiber reinforced plastic; other common names include glass-reinforced plastic (GRP) and glass-fiber reinforced plastic (GFRP). The manufacture of fiberglass products involves extrusion of the glass medium (fibers or ground glass) bonded with chemicals to form a shaped profile.

Advantages of fiberglass include overall strength and stiffness; ability to be molded into customizable shapes, fire resistant, relatively low maintenance, and good insulation characteristics and performance. It is increasingly popular for exterior trim, cornices, and siding to imitate wood, as well as gutters.

The disadvantage of fiberglass is it deteriorates over time due to exposure, particularly UV degradation resulting in cracking, brittleness, fading and discoloration. Constant exposure to UV light causes a weakening of the glass fibers resulting in particles becoming airborne. This requires recoating approximately every 5 years. The breakdown of the outer layer(s) impacts the performance and appearance of the material. Fiberglass is not recyclable thus its use is not recommended as a sustainable practice.

Fiberglass is appropriate when used as insulation and can be appropriate on a case-by-case basis for isolated, non-structural ornamental details. Use on upper stories or secondary façades is preferred, where the material difference is less discernible to pedestrians. Applicants should consider the balance between aesthetics, durability, and life-cycle sustainability.

COMMON ISSUES & TYPES OF DETERIORATION

The deterioration of exterior woodwork is particularly affected by environmental influences such as moisture, sunlight, insects, vegetation and biological growth. Climate change may exacerbate these conditions. Regular inspection, maintenance, and minor repairs can slow the rate of deterioration and preserve historic fabric in place.

Signs of wood deterioration include **paint failure, nail popping, splintering, warping, cracking, rough surfaces, and softening and rotting of the wood to the point that it is easily punctured with hand tools.**

Covering wood siding or trim with aluminum or vinyl siding is an oft-seen alteration that can trap water and prevent the proper evaporation of moisture, which leads to wood decay and deterioration. While clapboards and trim establish the historic character of a house, aluminum and vinyl siding destroy its architectural integrity by encasing it in an artificial skin. Often important ornamental details are removed because it is easier to install siding on flat surfaces, than to work around brackets, quoins, window casings, and door trim. The number of nail holes required for installation will damage the clapboards and the covered materials (usually wood clapboards) cannot be maintained.

An insensitive choice of materials can exaggerate the problem. For instance, siding with an 8" exposure is inappropriate for a house that formerly had 4" clapboards. Also, the attempt to imitate wood by choosing siding with artificial graining makes the contrast between genuine and substitute materials even more obvious. Aluminum or vinyl siding is usually installed for one of two reasons: to mask existing problems or to reduce the maintenance cost of painting. While siding may cover a problem, it will not rectify it and may even accelerate existing causes of damage. Paint failure and clapboard damage are often caused by faulty gutters and downspouts. If this drainage system is not repaired before installation, runoff water may get trapped behind the siding, causing even more damage.

USEFUL LINKS

National Park Service,
[Preservation Brief #10: Exterior Paint Problems on Historic Woodwork](#)

EXAMPLES OF TYPICAL WOOD ARCHITECTURAL FEATURES

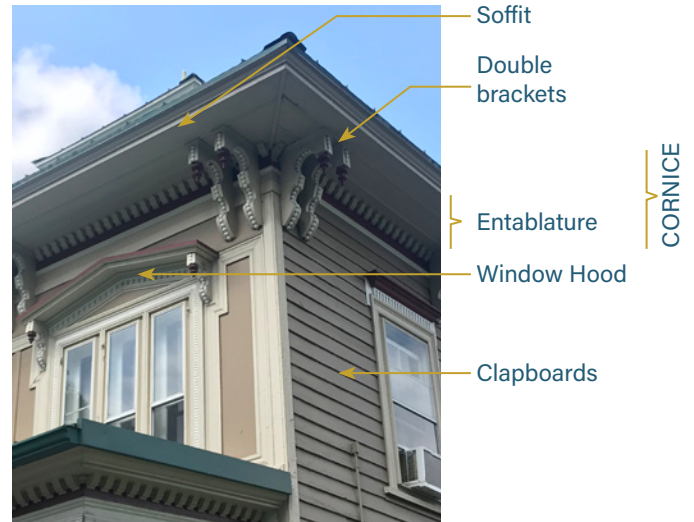

3.3 EXTERIOR ENVELOPE: MASONRY

Brick and stone masonry are two of the key building materials in Milford, with local bluestone being the most common type. A building's masonry is an essential component that defines the building envelope. Exterior masonry contributes both visually and functionally to the historic district's overall feel. Maintaining and repairing existing materials should always be the first approach when planning a project. The variety of materials, colors, and textures of masonry buildings should be preserved as they contribute to the visual distinction of Milford.

MAINTENANCE RECOMMENDATIONS

3.3.1 Maintain and preserve original exterior masonry walls and details. Clean using the gentlest methods possible to remove dirt, staining, and biological growth that might be obscuring other conditions. Avoid excessive use of water and saturation of masonry walls. Clean masonry only as necessary to inspect conditions or prepare for repair/restoration work. Sandblasting and high-pressure abrasive methods can result in irreparable damage and are never appropriate methods.

3.3.2 Identify and preserve decorative masonry elements that are important character-defining features, such as brick corbels and carved lintels. Avoid altering, concealing, or removing decorative masonry.

DESIGN GUIDELINES

3.3.3 Repair and restore brick masonry. Attempt to repair deteriorated or damaged areas prior to replacement. Appropriate brick repairs include repointing (repairing mortar joints), brick stitching, and select brick replacement. Avoid removing excess material or a larger area than is required to complete the repair. Any new brick masonry units should match the existing in color, profile, dimension, surface texture, and composition and physical properties. Replicate the existing brick bond or decorative patterns.

3.3.4 Repair and restore stone masonry. Attempt to repair deteriorated or damaged areas prior to replacement. Appropriate repairs include repointing, crack repair, Dutchman repairs (in-kind localized patching), and patching with compatible compounds. Any new masonry units should match the existing in type of stone, color, profile, dimension, and surface texture.

3.3.5 Repoint brick and stone masonry with a compatible and historically appropriate mortar that matches the original in composition, strength, hardness, color, and texture. Match new mortar joints to surrounding areas in width and

tooling profile. A compatible mortar is necessary to avoid future damage to the masonry and a disjointed appearance. Cut back and repoint mortar joints using hand tools only; mechanical grinders and similar power tools are not recommended as they can lead to excessive damage.

3.3.6 Replace or rebuild exterior masonry walls or feature with in-kind materials. Replacement masonry units should match the existing in color, profile, dimension, surface texture, and composition and physical properties. Replicate the existing brick bond (method by which the bricks are laid).

3.3.7 Avoid painting, sealing, or coating historically unpainted brick and stone masonry. Adding exterior coatings can trap moisture and cause deterioration of masonry walls and detracts from a building's architectural character.

3.3.8 For existing painted or coated masonry, maintain and repair the painted surface rather than attempt removal. Removal is not recommended due to the likelihood of damaging the masonry substrate. Consider removal of non-historic coatings only if they are demonstrated to be causing or exacerbating other types of deterioration. Avoid removing paint or coatings that are firmly adhered to the masonry.

JOINT PROFILES & BONDING PATTERNS



Brick masonry buildings are essential features of Milford's historic district. Details like brick segmented arches over windows should be preserved.



Bluestone is a distinctive local material that should be retained and preserved. Rough ashlar masonry, irregular sizes and coursing, and quoining at building corners are typical character-defining features.

COMMON ISSUES & CAUSES OF DETERIORATION

The use of brick and stone masonry construction is a defining characteristic of Milford's historic buildings. If properly maintained, these materials can last for centuries. However, deferred maintenance and improper repairs can result in deterioration.

Water infiltration is the most common cause of deterioration in brick and stone. Failure can occur in the masonry units themselves or the mortar that holds masonry in place. Infiltration can be caused by numerous factors: poorly functioning gutters, downspouts, and flashing; ponding water at foundations or projecting ledges; vegetation growing on or near walls; and non-breathable paints and sealants.

Water infiltration can cause rising damp and efflorescence to occur. Rising damp is groundwater that is absorbed into the base brick and stone walls through capillary action. Moisture evaporates at exterior and interior surfaces, which can stain the brick. Efflorescence is a white haze caused by dissolved salt migrating through the masonry. When water in the masonry evaporates, a layer of salt is left behind.

Improper past repairs and repointing are other typical causes of deterioration. Historic mortars are a mix of lime, sand, various types of small aggregate, and water. Newer mortar mixes contain Portland cement rather than lime (or in a much higher proportion than lime), resulting in a harder mortar. Lime-based mortars are softer, meaning that they are more pliable and adaptive to temperature-related expansion and contraction, and better allow air and vapor transmission, which protects the masonry units. Mortars that are harder than the masonry it surrounds force water and salts to permeate through the masonry rather than mortar, which can lead to spalling and cracking. Damage to masonry units makes exterior walls more vulnerable to water infiltration and creates more costly, time-consuming, and invasive repairs.

Aggressive cleaning methods can also cause deterioration. Harsh chemical cleaners, sandblasting, or high-pressure water or abrasive cleaners erode both the protective surface finish of masonry units and mortar joints, making historic masonry more vulnerable to deterioration and failure.

Past painting or coating of historically unpainted masonry can lead to deterioration, especially where non-breathable sealants were used. Incompatible paints (such as an elastomeric paint) and coatings trap moisture and prevent the natural evaporation of water and salts out of exterior wall assemblies.



Efflorescence is a white haze caused by the migration of salts through masonry units.



Mortar is incompatible with historic masonry when it is too hard and causes brick spalling and breakage.

REPAIR AND RESTORATION RECOMMENDATIONS

Repair and restoration of historic masonry can protect a building's structural integrity and its historic integrity. When addressing conditions like efflorescence or spalling face brick, it is critical to address the source of the problem to provide a long-lasting solution, rather than only performing aesthetic repairs. For masonry, this generally means tracing the route of water infiltration and conducting repairs for other building features.

Use the gentlest methods possible to clean exterior masonry walls. Gentle methods keep protective exterior layers or finished (textured or tools) faces intact. Man-made masonry products like brick generally have more durable exteriors created during high temperature firing processes that protect the more porous interior body. Sandblasting, high-pressure grinding, and harsh chemical strippers damage these protective outer layers by eroding, chipping, or entirely removing them. The porous body is exposed and absorbs water more easily, leading to more severe deterioration through freeze/thaw cycles, cracking or spalling, and efflorescence. Using the gentlest means possible protects the performance of masonry materials, as well as preserves their original colors and surface textures.

When cleaning, conduct inconspicuous test patches to determine the gentlest and most effective method. Cleaning with low pressure water or misting and soft hand brushes is the most basic method. Pressure is measured in psi (pounds per square inch) and should be below the maximum of 300-400 psi. Care should be taken not to saturate the wall

and introduce unnecessary water. Mild and environmentally safe chemical cleaners are another acceptable method. New technologies for low pressure, micro-abrasive cleaning methods have emerged that are gentle enough to remove dirt without compromising surface layers and have been approved for use by the National Park Service.

Soft, lime-based mortars are generally the most appropriate for repointing. Any repointing mortar should have little to no Portland cement in the mixture and should be designed for the specific type of historic masonry. Compatible repointing mortar must take into account the masonry units and the historic mortar. Following the National Park Service Preservation Brief 2 “Repointing Mortar Joints,” mortars for repointing should be softer or more permeable than the masonry units and no harder or more impermeable than the historic mortar to prevent damage to the masonry units. Stresses within a wall caused by expansion, contraction, moisture migration, or settlement must be accommodated in some manner; in a masonry wall, these stresses should be relieved by the mortar rather than by the masonry units. Mortar should be sacrificial to masonry, because it can be repaired easily and preserves the structural integrity of the masonry units.

Knowing the period of construction of a building and the sequence of past repairs can help determine the appropriate mortar for repointing. Laboratory testing of mortar samples by an architectural conservator can identify the specific historic mixture and select a custom-blended repointing mortar to match the original.

Painting historically exposed masonry is not advised. Where masonry has been painted, depending on the type of paint used, removal can prove impossible and/or economically infeasible because of the time and material costs required. An additional concern is the condition of the brick masonry once the paint is removed. The brick may be in a deteriorated state that cannot be repaired which will require face brick replacement (replacement of the outermost layer). Coating historically exposed masonry with stucco is also not advised. Common repairs to existing stucco are patching and crack repair. The patching material should match or be compatible with the composition of the coating.

In rare cases where application of a coating is advised to protect deteriorating brick, applying a breathable masonry paint is a recommended alternative and has been approved by the National Park Service. A permeable paint, such as a mineral silica type paint, allows the masonry to breathe and water to evaporate. Addition of a coating should

be determined with a qualified design professional and contractor. Technical product information and documentation of the condition that necessitates an intervention should be provided to the HARB for review.

MORTAR TYPES

Five mortar types have been established by the American Society for Testing and Materials (ASTM) to distinguish high strength mortar from soft flexible mortars. The critical properties are each type's strength and proportion of cement, lime, and sand (expressed as a ratio of cement:lime:sand),

Type M: 2,500 psi, 4:1:12

Type S: 1,800 psi, 2:1:8

Type N: 750 psi, 1:1:5

Type O: 350 psi, 1:2:8

Type K: 75 psi, 1:3:10

Type L: low strength, 0:1:3

Soft, high lime content mortars are best for historic properties. Type O is typically specified for repointing. Type N can be appropriate for load-bearing masonry. Mortar can be mixed with pigments or other additives to match historic colors and textures.

USEFUL LINKS

National Park Service, [Preservation Brief #1: Assessing Cleaning and Water-Repellent Treatments for Historic Masonry Buildings](#)

National Park Service, [Preservation Brief #2: Repointing Mortar Joints in Historic Masonry Buildings](#)

National Park Service, [Preservation Tech Notes, Masonry #4: Non-Destructive Evaluation Techniques for Masonry Construction](#)

Masonry Features: Foundations

Foundations are one of the most important features to consider while preserving historic buildings since they maintain a building's structural integrity. Without proper maintenance, foundations must be repaired or replaced through a labor-intensive process. Historic foundations in Milford are masonry and concrete. To preserve historic buildings it is critical to maintain and care for foundation materials.

MAINTENANCE RECOMMENDATIONS

3.3.9 Protect and maintain historic foundations by designing landscaping and other site features to keep water from collecting near the foundation walls. Ensure that gutters and downspouts are clear and effectively direct water away from the foundation walls.

DESIGN GUIDELINES

3.3.10 Repair and restore original foundations whenever possible. Repoint original masonry foundations to retain the original design and use compatible mortar in strength, mixture, and permeability.

3.3.11 Retain and repair windows, grates, or screens in existing openings in foundation walls. Creation of new openings on the street-facing façades of an original foundation is not appropriate. New windows or penetrations to accommodate utility equipment may sometimes be acceptable on non-visible façades.

3.3.12 Replace historic foundation materials in-kind if the existing masonry is beyond repair and structurally compromised. If the foundation material cannot be repaired or patched, only replace the minimum amount of material needed to make the repair. Use original materials and details. If original materials are not available for the foundation replacement, choose new materials that convey the scale, texture and appearance of the original.

3.3.13 Avoid applying a coating over an exposed masonry foundation to hide an original deteriorated material. Identify and address the source of deterioration as soon as possible.

3.3.14 Avoid increasing a building's height when repairing or replacing a foundation wall as it will alter the proportions of the building and impact the surrounding streetscape. Provide HARB with an engineering report if raising a foundation is necessary for structural reasons.

COMMON FOUNDATION TYPES

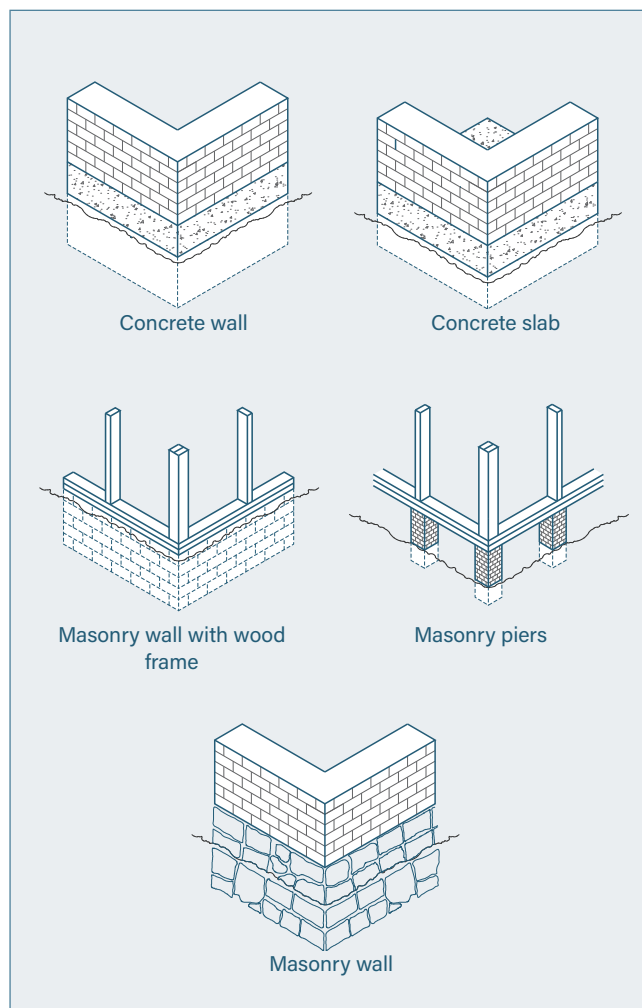

3.4 ARCHITECTURAL METALS

Architectural metals in Milford, such as fences, railing, and other metallic features, should be preserved. Typical historic metals were copper, aluminum, zinc, steel, terneplate, wrought iron, and cast iron. Historic metals are both aesthetic and functional elements of a property. The guidelines for historic metals apply to all types of features, even those not explicitly mentioned in this chapter. Historic architectural metals should be preserved and restored.

MAINTENANCE RECOMMENDATIONS

3.4.1 Maintain historic metals by inspecting for dents, cracks, perforations, open seams, corrosion, or rust (a type of corrosion if the metal contains iron).

3.4.2 Maintain historically painted or coated metals by keeping surface well painted and intact.

3.4.3 Clean metals using the gentlest methods possible and using products compatible with the type of metal. Cleaning is only recommended to remove corrosion, soiling, or biological growth prior to repair or repainting. Cleaning is not recommended only for appearance. Avoid harsh abrasive or chemical cleaners as they may cause further deterioration, pitting, or scarring. Natural patinas should be left intact.

DESIGN GUIDELINES

3.4.4 Retain and preserve architectural metals as character-defining features of historic buildings and historic district. Covering or concealing historic metal features with new materials (such as vinyl), or removing features without replacing them in-kind, is not appropriate because it negatively impacts historic character.

3.4.5 Repair and restore historic metals whenever possible. Repairs include soldering, stitching, sealing, and localized in-kind replacements.

3.4.6 Replace in-kind if metals are severely deteriorated. In-kind replacements should match the original in type of metal, color, finish, texture, profile, and appearance. Replacement copper is an exception for color matching; new copper should not be painted or coated and should weather naturally to develop its natural green-color patina.

3.4.7 If in-kind replacement is not feasible, use an alternative metal that replicates the original in texture, finish, level of detail, and appearance as closely as possible. Vinyl or other synthetic materials are not appropriate as alternative materials, as these substitutes do not sufficiently replicate the appearance of historic metals.



An example of a historic architectural metal is the 19th century cast iron fence at 108 East Ann Street

USEFUL LINKS

For more information about the history and preservation of architectural metals, see: [Metals in America's Historic Buildings.](#)

3.5 WINDOWS

Original windows are one of the most important characteristics of historic buildings. The shape, size, and style of windows are distinguishable features of most architectural styles. Windows on primary façades are essential to retain. Alterations to windows are highly noticeable and can easily detract from a building's historic character. Windows are often one of the first elements of a historic building to be altered or replaced, yet they can be easily and effectively repaired and retained. These guidelines are based on tiered levels of intervention with the overarching principle that original windows should be maintained, repaired, and reused to the greatest extent possible.

MAINTENANCE RECOMMENDATIONS

- 3.5.1** Maintain and preserve historic windows and all associated components whenever possible, including window sash, frame, sill, casing, trim, hood, shutters, and glazing (glass). Most historic windows in Milford are wood. Retain original windows in type, shape, size, configuration, and material. Preserve existing glazing including stained glass, beveled glass, and multi-color glass.
- 3.5.2** Keep historic wood windows in good condition by maintaining sound layers of paint at exterior and interior surfaces. Where wood has been exposed by paint failure, clean with the gentlest methods possible and consider treating with fungicide prior to repainting. Scrape peeling or flaking paint using hand tools down to the next sound layer of paint and ensure that the surface is clear of dirt and debris before priming and repainting.
- 3.5.3** Inspect hardware and test operation. Ensure sash locks bring sashes together tightly to keep windows watertight.
- 3.5.4** Remove paint that has sealed a window closed from the exterior and/or interior to allow windows to be operable and naturally circulate air.
- 3.5.5** Consider adding weatherization improvements that have minimal impact to historic fabric including sealing or re-caulking around exterior and interior trim, installing weatherstripping, and installing storm windows (either exterior or interior).
- 3.5.6** Install storm windows customized to fit each window frame properly. Wood and aluminum materials are appropriate. The horizontal rails should align with window sashes. Storm window finishes should be painted to match the window trim or blend with the color scheme of the building. Interior storm windows may be recommended for windows with distinctive lites to preserve the exterior appearance.

DESIGN GUIDELINES

- 3.5.7** Repair, restore, and reuse original windows as the preferred preservation treatment. Where one component of a window is deteriorated or broken, repair or replace the individual piece rather than replace the entire window unit. Repair or selectively replace in-kind existing hardware to ensure window operability, including sash cords, weights, and pulleys.
- 3.5.8** Replace original wood windows in-kind if they are deteriorated beyond repair. Replacement windows should match the original as closely as possible in material, type, size, operation, profile, and appearance. Replicate the existing dimensions of glazing, configuration of muntins, or unique decorative lites. Match sash and frame thickness and window depths. Applicants should submit documentation to HARB if claiming repair is not feasible.
- 3.5.9** Replace wood windows with alternate materials only on a case-by-case basis if in-kind replacement is not feasible based on the material. Replacement windows shall match the original as closely as possible in type, size, shape, operation, profile, configuration of lites and muntins, and exterior finish and texture. Aluminum-clad wood windows are an appropriate alternate because they can replicate the original appearance and material. Composite wood or fiberglass windows with paintable exterior surfaces can be appropriate alternates if they match the original appearance, but are not recommended from a sustainability perspective. Vinyl windows are not appropriate due to short lifespan, poor performance, and inability to match historic profiles.
- 3.5.10** Replace non-historic windows (previous replacements) with acceptable alternate materials (see 3.5.9) or new wood windows. Replacements should match the existing type, size, shape, and appearance or restore a historically appropriate design to the building. Replacement of vinyl windows with new vinyl windows is not appropriate.
- 3.5.11** If replacing a single window on a façade, replicate the existing windows of that façade.

COMMON WINDOW SHAPES & STYLES

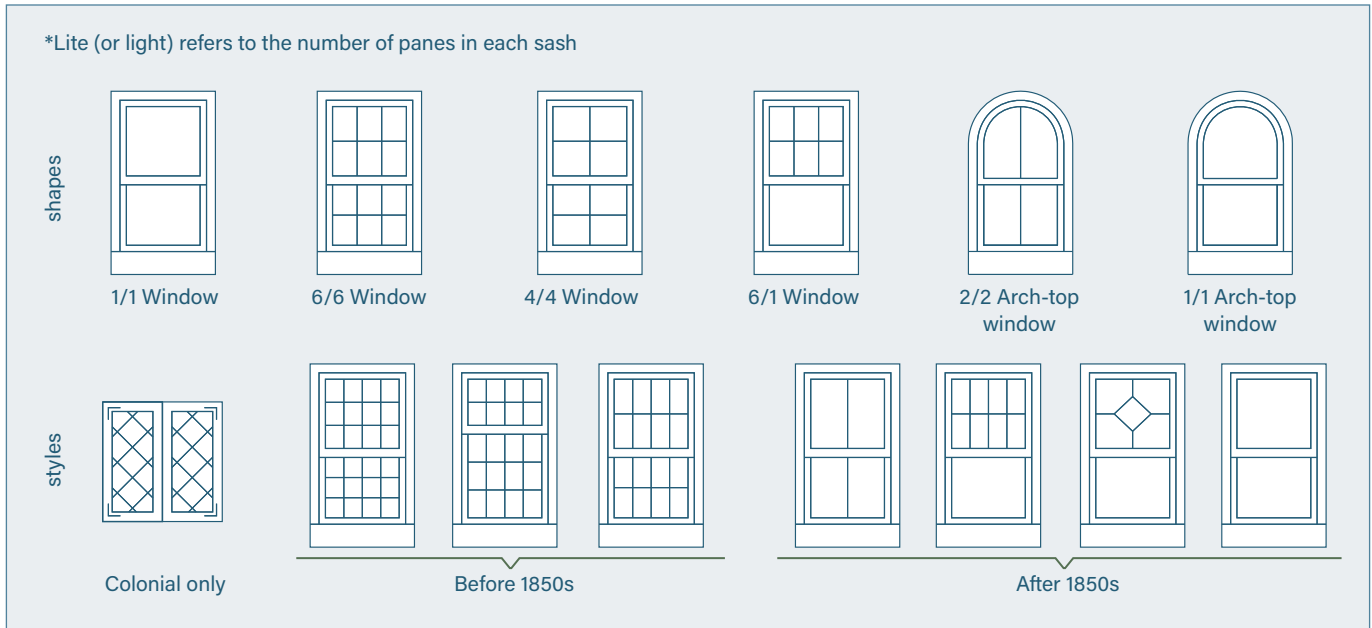

3.5.12 Replace single-pane glazing in-kind whenever possible. Double-glazed windows with simulated divided lights are an acceptable alternate if simulated divided light muntins are affixed to the window exterior and metal spacers are used between the glass. Replicate the dimensions, details, and appearance of the original window.

3.5.13 Avoid reflective glazing in restored or new windows. Reflective glazing makes a window’s lites and muntins difficult to see and alters the visual impact of the window from the public right-of-way. This change makes alterations in the historic district more conspicuous. Clear (non-tinted) and non-reflective glazing and low-e coatings are appropriate.

3.5.14 Preserve the ratio of window openings to solid wall surfaces. Increasing or reducing openings can impact the proportions of a façade and can look out of place within the larger streetscape.

3.5.15 Retain the historic pattern of window openings (fenestration pattern), especially on primary façades. Avoid inserting new windows into a façade or infilling existing windows. The position, number, and arrangement of windows defines the rhythm of a façade and can be a character-defining feature of an architectural style or a type of building use. If creating new openings or infilling existing ones is necessary for a project, locate openings on side or rear façades.

3.5.16 Replace deteriorated window trim or decorative elements only as necessary to match the size, profile, and material of the original elements. For window lintels or hoods that project from the façade plane and are vulnerable to water collection, consider installation of metal drip edges to shed water away from windows. Copper is recommended and should be left to weather naturally; painted aluminum is acceptable if painted to match trim.



Example of a 6/6 double-hung wood window, a common historic type throughout Milford.



Example of a 1/1 wood window with Queen Anne style multi-color lites in the upper sash.

TYPICAL WINDOW OPERATION SYSTEMS

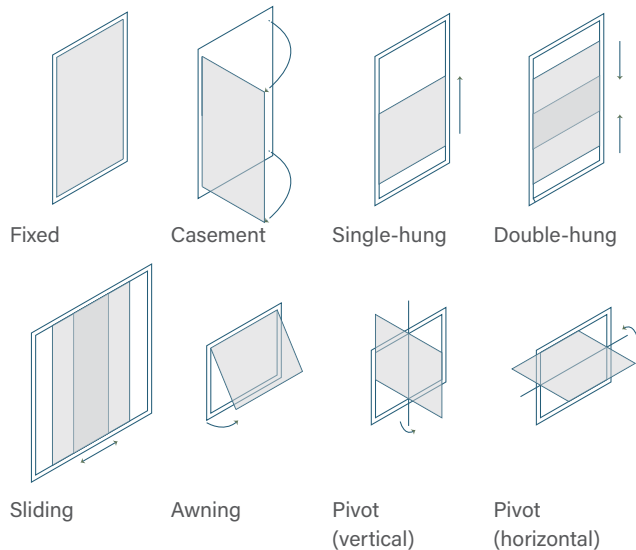

COMPONENTS OF A TYPICAL DOUBLE-HUNG WINDOW

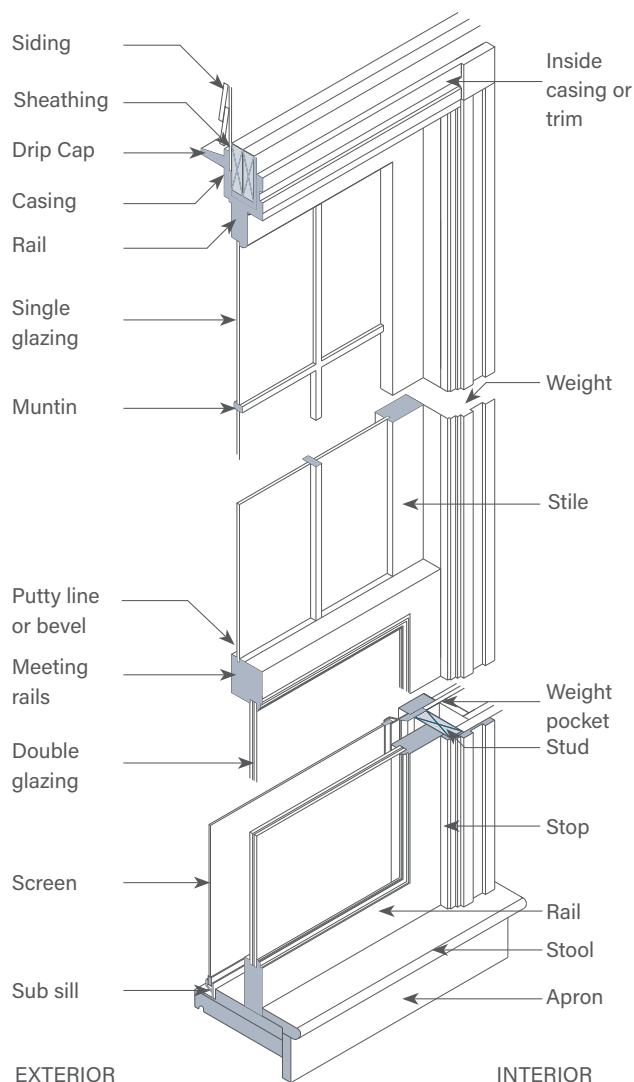

TYPICAL WINDOW MATERIALS

The vast majority of historic windows are made of wood. Use of traditional wood for windows is recommended for reasons of historic and material integrity, aesthetics, and durability. Despite advancements in new materials and window products, synthetic materials often do not sufficiently resemble original materials, have a short lifespan, and use less sustainable materials. Well-maintained wood windows can last longer, be repaired, and enhance a building's historic character. Original wood windows remain intact in the historic district and should be retained. Many windows have already been replaced and therefore have more flexibility in material.

REPAIR AND RESTORATION RECOMMENDATIONS

One advantage of historic windows is that they were made as an assembly of individual components; when one component breaks or fails, only that piece needs to be repaired or replaced. This construction extends the longevity of historic windows and allows original materials to remain in place as long as possible. Small, localized repairs can be more cost-effective than entire replacement, in addition to being preferred from a preservation perspective. Repaired windows have also been shown to achieve energy performance levels comparable to replacement windows. New modern windows are manufactured as entire units, meaning that once one component is damaged, the entire window must be replaced.

Historic windows can be repaired and restored even when deterioration appears severe. Repair small cracks, dents, and gouges in wood surfaces with wood filler. Larger areas of deteriorated or rotted wood can be restored with Dutchman repairs or by consolidating the wood with epoxy mixtures. A Dutchman repair is a localized method where unsound material is cut out and new wood is pieced-in or spliced into the surrounding wood. Repair loose glazing by installing new glazing putty and repairing the muntins or sash members that hold glazing lites in place.

Keeping wood windows well painted will extend their lifespan. Prior to repainting, wood windows should be cleaned and flaking paint gently removed to the next sound layer of paint. Preparation of the wood substrate is important so the new paint will adhere properly. Use a paint type that will adhere properly to the wood surface, such as oil-based paint. Marine grade paints are recommended because they perform well in wet coastal climates over long periods of time.

WINDOW REPLACEMENT

When proposing a historic window replacement, applicants should be prepared to demonstrate that all other repair and restoration options have been studied and that replacement is the only reasonable option. The feasibility of the following will be assessed:

- » Restoration of the entire existing window through repairs to sashes, sills, and individual components;
- » Individual sash replacement;
- » Full replacement of windows with exact in-kind matches and matching the existing window layout.

Factors of cost, labor, and condition will be considered in determining the best course of action. Applications to repair historic windows or replace window sashes with exact duplicates can have an expedited review if they meet the following conditions: no changes in window material, grid pattern (number of divided lites) or grid width, sash widths, glass treatment, or frame type.

TRUE VS. SIMULATED DIVIDED LITES

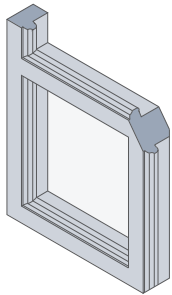

True Divided Lite
Separate pieces of glass between muntins. True divided lites are the most historic construction method.

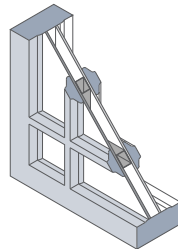

Simulated Divide Lite with Spacer
Mimics the look of true divided lites with muntin grilles permanently adhered to both sides of the glass. A metal spacer bar is installed between the glass panes.

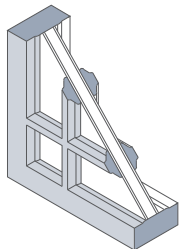

Simulated Divide Lite without Spacer
Muntin grilles are adhered to the glass. Without spacer bars, the window does not adequately mimic historic windows with true divided lites.

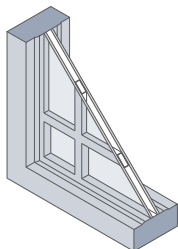

Grilles-between-the-Glass
Grilles permanently installed between the glass panes. Interior grilles do not convey lite configurations and impact visual character.

ENERGY EFFICIENCY NOTE

When looking to improve a building's energy efficiency and reduce heating and cooling costs, many people jump to window replacement. However, other building features and systems may be responsible for energy losses. Roof insulation and equipment upgrades are typical priority items. Repair of historic windows and low-impact weatherization can usually achieve the same energy efficiency as a new window.

The best first step in planning energy efficiency upgrades is to conduct an energy audit. An energy audit analyzes the building's thermal performance. It identifies if energy loss is occurring and where—which means homeowners can upgrade the priority areas first and can avoid making unnecessary changes to historic materials. Learn more about energy audits and windows in the National Park Service's [online Weatherization guide](#).



UV COATINGS & FILMS

The challenge of improving the energy efficiency of buildings with single pane windows and doors without affecting the historic appearance of the buildings can be accommodated with exterior storm windows and the application of window film that has no visual impact. Products on the market include UV protection film and thermal climate control window film that have no visual impact and can improve the window's energy efficiency by reducing the solar heat gain coefficient and U-value-heat loss. UV coatings help protect the historic fabric of a building including textiles, art, furnishings, as well as people from the damaging effects of UV rays. The film can be applied to the glazing if single pane and can be a laminated inter-layer if using double pane glazing.

Testing small-scale and low-impact solutions to improve an existing window's efficiency is a beneficial step before proposing full replacement.

GUIDE FOR REPLACEMENT OF HISTORIC WINDOWS

When replacing a window, new dimensions should match existing or original measurements for each component. To accurately replicate any window, it is crucial to recognize the compatibility between the original and the replacement in terms of shape, size, operation, and materials. Below are the most common dimensions you need to consider when

replacing a window, in addition to the overall height and width of the window opening.

The HARB looks for the size and shape of the new window to match the original, as well as the size and shape of individual components, and the proportion of those components to each other.

Single and double hung windows

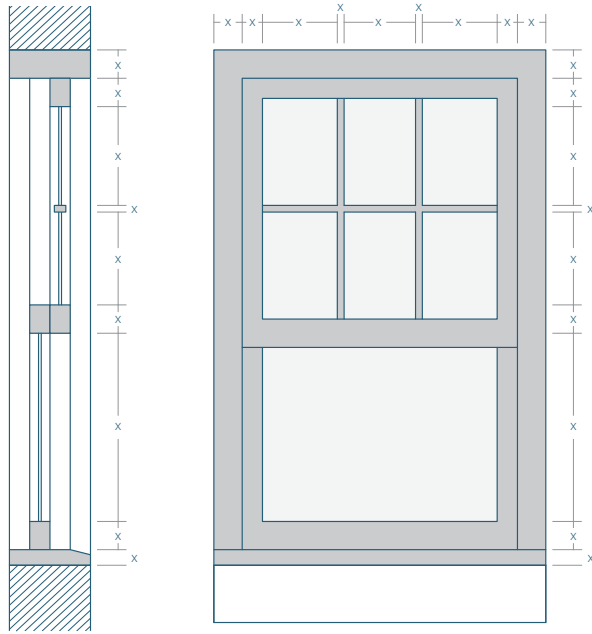

Inappropriate replacements

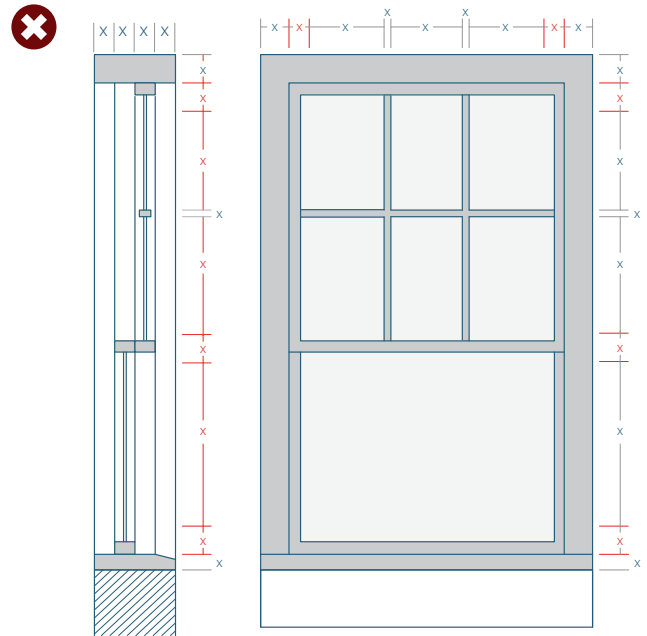

Casement or fixed windows

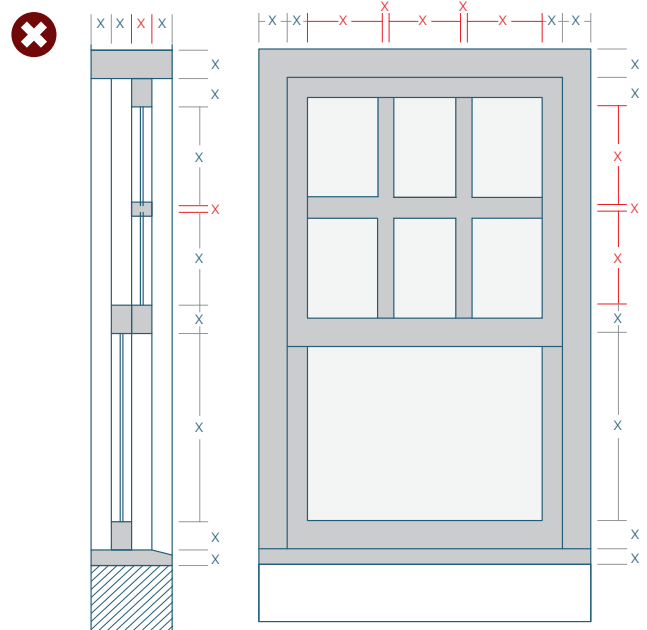
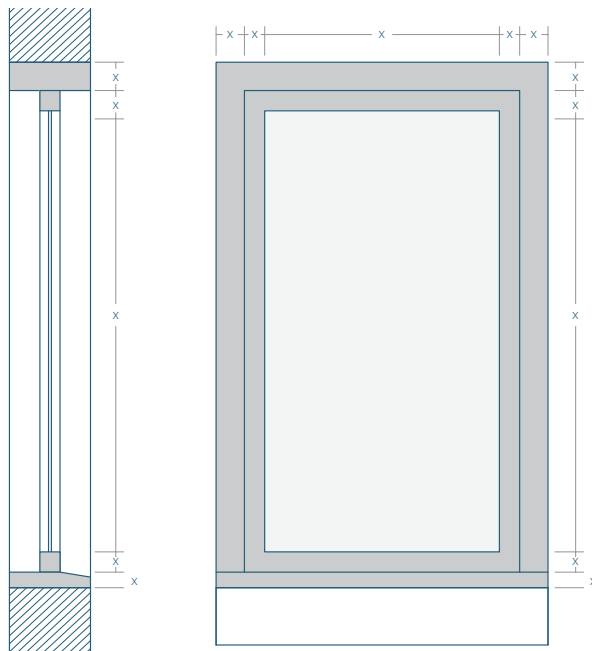

Replicating dimensions is important for appropriate replacement windows. Even small changes can impact the overall appearance, like different sash rail and stile size (top) or muntins (bottom).



An example of a historic multi-lite wood window and wood storm window.

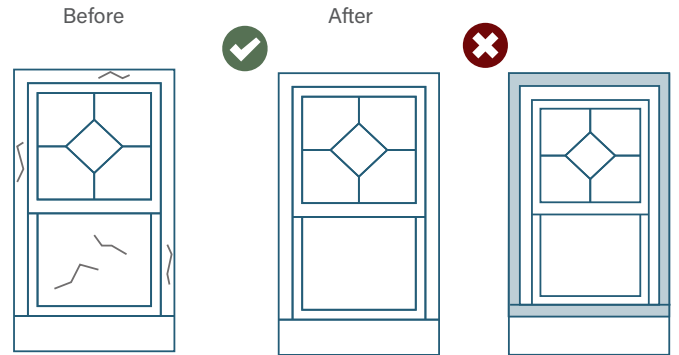

Repair and reuse of original windows is the most appropriate treatment, followed by in-kind replacement that matches the original and matches the original size.

Some replacement methods leave the old frame intact inside the structural opening (shaded above) and install a new frame and assembled window on top of the old. This method is not appropriate because it shrinks the window and changes the façade transparency, even if the replacement window matches the original design.

WHY PRESERVE HISTORIC WINDOWS?

Historic windows can be repaired and restored in parts, rather than entirely replaced like new windows must, reducing material waste and long-term costs.

Simple repairs of caulking, weatherstripping, and replacing glazing compound can address air transfer between a sash, frame, and wall.

Low-impact alterations like storm windows and interior films are effective improvements for heat gain/loss through glazing. Interior storm windows have less visual impact than exterior.

Preservation conserves the energy already expended to make the windows.

Historic windows are essential aesthetic elements that preserve the appearance, proportion, and material texture of a building.

USEFUL LINKS

For additional window resources refer to:

National Park Service, [Preservation Brief 9 “The Repair of Historic Wooden Windows”](#)

National Park Service, “Planning Successful Rehabilitation Projects,” [“Evaluating Historic Windows for Repair and Replacement”](#) and [“Replacement Windows that Meet the Standards”](#)

National Trust for Historic Preservation, [“Historic Wood Windows” Tipsheet](#)

National Trust for Historic Preservation, [Saving Windows, Saving Money: Evaluating the Energy Performance of Window Retrofit and Replacement](#)

For weatherization guidance, including windows and doors, refer to National Park Service, [“Weatherization: Repair and Upgrade Windows and Doors”](#)

3.6 DOORS

The composition of a door and its surrounding trim are significant architectural features. The proportion, shape, and detail of historic doors contribute to the architectural style of the building. The relationship between a primary entry, primary façade, and the street also contributes to the historic feel of a district. Doors and entrances should be maintained and preserved.

MAINTENANCE RECOMMENDATIONS

3.6.1 Keep doors in good condition by maintaining sound layers of paint at exterior and interior surfaces. Historic doors are typically made of wood. Where wood has been exposed by paint failure, clean with the gentlest methods possible prior to repainting. Scrape peeling or flaking paint using hand tools down to the next sound layer of paint and ensure that the surface is clear of dirt and debris before priming and repainting.

3.6.2 Maintain doors by keeping hardware in good operation. Damaged or deteriorated hardware can cause doors to become out of plumb with the opening and not operate properly. Individual repairs or in-kind replacement helps maintain historic doors.

3.6.3 Consider adding weatherization improvements that have minimal impact to historic fabric before considering door replacement. Improvements include installing weatherstripping and installing storm doors. Weatherization and repairs should be attempted first and their performance monitored.

3.6.4 Install exterior storm door with a full-light (full view) appearance to keep the visibility of the original historic door. Storm doors should be finished or painted to blend in with the door trim.

DESIGN GUIDELINES

3.6.5 Repair and restore historic doors whenever possible rather than replace them. Original materials should not be discarded. If repair and reuse is not possible, salvage may be an option and the existing feature used as a template for replication.

3.6.6 Repair, restore, and reuse existing door frames, jambs, threshold, fixed transoms, and similar components. Existing components are usually historic wood. Replace in-kind if existing materials are severely deteriorated. Replicate the profile and width of door frames, jambs, and transoms in order to preserve the solid-to-void ratio of the entrance.

3.6.7 Retain and preserve existing door openings. Avoid enlarging or filling in original door openings to fit new stock sizes.

3.6.8 Repair and reuse hardware whenever possible. Replace hardware in-kind if necessary. New hardware should match the original hardware in material, finish, appearance, and function. If original hardware is no longer intact, new hardware should be compatible with the era of construction and style of the building. Avoid replacing historic hardware with contemporary designs, digital locks, combination locks, keypads, or similar technology.

3.6.9 Replace doors in-kind if repair is not feasible. Replacement doors should duplicate the original in material, design, size, profile, operation, and hardware. Original doors may be used as a template for replication. If the original design is unknown, the stylistic period of a building should inform the appropriate replacement.

3.6.10 Replace with durable alternate materials if in-kind replacement is not feasible. Composite wood doors and fiberglass doors are acceptable replacements if new doors match the original in size, style, configuration, detail, and appearance. However, these products are not recommended from a sustainability perspective. They have shorter lifespan and deteriorate when exposed to moisture, weathering, and temperature variation. For replacement doors, avoid metal doors (including metal doors that imitate paneled wood), as they do not have the same appearance and texture of historic wood. Avoid pre-hung doors (doors that are purchased already installed in a frame) when replacing a door, because these require the removal of historic fabric and can change the size of the opening.

3.6.11 Preserve the size of the existing door opening. New doors should be custom sized if necessary. Avoid enlarging or filling in original door openings to fit new stock sizes. This alteration will impact the historic rhythm of the façade.

DOOR COMPONENTS & TYPICAL SURROUNDS

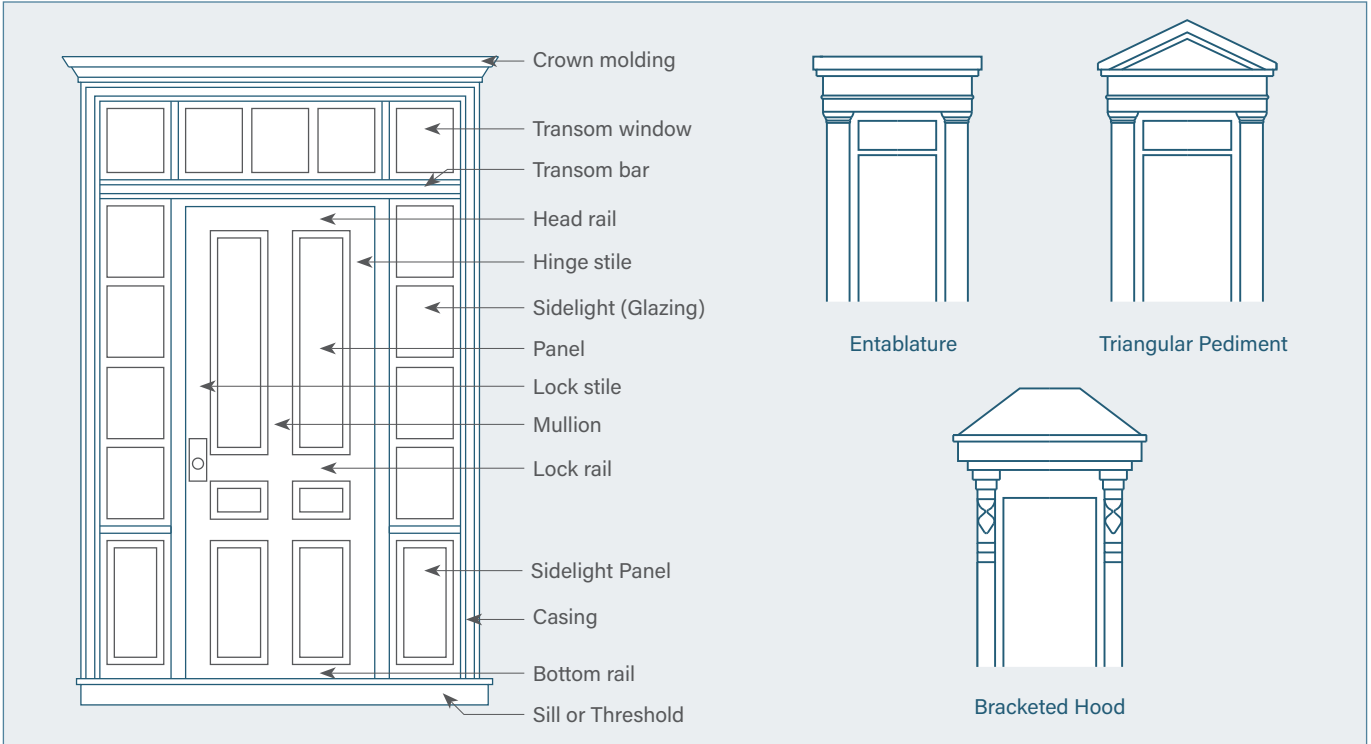

3.6.12 Avoid introducing new door openings on the primary façade or highly visible façades of a building. New side or rear doors should be minimally visible from the street. Doors above ground level that are necessary

3.6.13 Avoid replacing of a historic door solely for the purpose of improving thermal performance. This intervention is not appropriate for historic material. Install weatherproofing or a storm door prior to replacement.

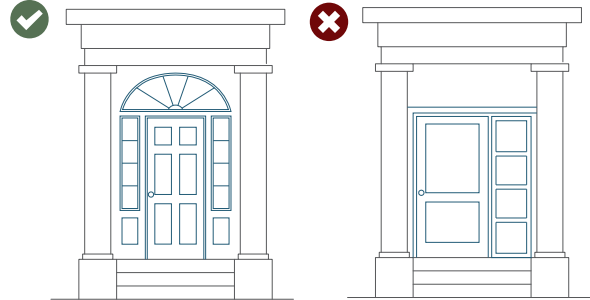

Maintain style, materials, configuration, and rhythm or symmetry when restoring doors and entryways.

It is not appropriate to change style, materials and configuration of original historic doors with contemporary designs.

ACCESSIBILITY

When entrance alterations are necessary to improve accessibility, contact the HARB early in project planning to develop the most appropriate solution. Refer to [Chapter 3.14 Accessibility & Code-Required Work](#).

3.7 PORCHES, EXTERIOR STEPS & STAIRS

Front porches and entry steps are distinctive characteristics of Milford’s historic architecture and streetscapes and should be retained and preserved. Common forms include single-story porches and two-story porches. Many porches in Milford include unique ornamental elements. The following guidelines apply to all types of front and rear porches visible from the public right-of-way.

MAINTENANCE RECOMMENDATIONS

3.7.1 Clean porch roof drainage systems regularly. Ensure that water drains away from the building foundation.

3.7.2 Keep wood elements well painted. Paint acts as a protective layer for the wood below and prevents rotting and deterioration.

DESIGN GUIDELINES

3.7.3 Repair and restore existing porches and steps whenever possible. Salvage, repair, and reuse existing components including deck floor boards, railings, balusters, posts, and decorative trim. Repair and restore basement level windows or grates that are part of the porch base.

3.7.4 Replace individual deteriorated components in-kind with new materials matching the original in material composition, size, shape, profile, dimension, appearance, and finish. Custom fabrication is encouraged and may be necessary to provide an exact match. Where an exact match of the historic element cannot be found or fabricated, the new element should match the original as closely as possible.

3.7.5 Retain and repair original handrails or railings. Replace in-kind if repair is not feasible. Replacement handrails should match the existing in material, size, and appearance as closely as possible. Installation of handrails where they did not previously exist is generally not recommended due to the visual and physical impact on historic fabric; however, installation of a simple, compatible design may be acceptable for the purpose of safety and ease of access.

3.7.6 Replace original wood and metal components with appropriate alternate materials if in-kind replacement is not feasible. Alternate materials should respect the original appearance and be a high-quality durable material. Composite wood decking is an appropriate alternate for tongue-and-groove wood floors if boards are similar to

the original dimensions. Steel, iron, and aluminum railings are acceptable replacements. Fiberglass elements are not recommended for sustainability and longevity. Vinyl posts, railings and trim are not appropriate alternate materials for wood elements. Exposed dimensional lumber for parts of a porch is not appropriate.

3.7.7 Avoid enclosing historically open porches on primary and highly visible façades. Enclosure with glass or screens at rear or non-visible features may be acceptable. Enclosure with walls or opaque materials is not recommended. Avoid removing, altering, or covering historic details.

3.7.8 Avoid removing a historic porch, portico, or flight of entry steps. Removal will negatively impact the building’s historic character.

TYPICAL MATERIALS

Wood, wrought and cast iron, masonry, and concrete are the typical historic materials for porches. Common historic materials for entry steps include concrete, brick, and bluestone.

Many porches in the historic district have already undergone one or several alterations. These changes may have occurred long before the historic district was designated. Common changes include replacement of turned wood posts for metal posts, capping or removing decorative trim with vinyl, and roof replacements. Although these materials are existing and may have been intact for many decades, it is not desirable to replace them in-kind. From a historic preservation perspective, restoration of the original appearance is preferred with the original material or an acceptable alternate.

ALTERNATIVE DECKING MATERIALS

Composite decking materials made from recycled materials including reclaimed wood and sawdust and plastic packaging are earth friendly, durable, pest resistant, mold and mildew resistant and can be manufactured in color, texture and dimension to match authentic wood decking and therefore can be appropriate for use in the replacement of wood decking on non-primary façades. Composite decking is long lasting, reduces the need for replacement and repair and is the same or lighter weight than wood decking materials.

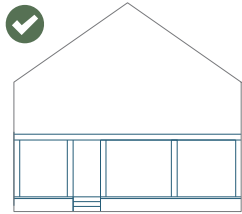

Porches should be restored with in-kind materials and following their original architectural style and proportions



A porch should not be enclosed to generate additional interior space to the original construction

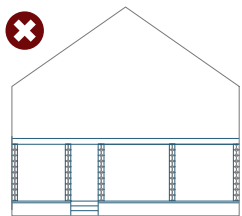

Avoid the use of metal or visibly alternative materials when replacing porch supports or columns

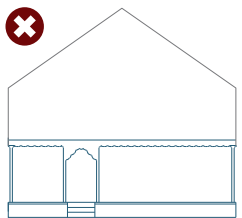

It is not appropriate to change the original architectural style of the porch

DOORS & PORCHES



The multi-lite wood door surrounded by sidelites and a transom, and the delicate carved wood porch elements is a typical 19th century revival style entrance.



Typical historic porch components include turned wood balusters and handrails, wood steps, tongue-and-groove wood decking and ceilings, and elevated masonry foundations.



Ornate Italianate- and Queen Anne-style wood porches and paneled double wood doors create a monumental entrance that contributes to the district's streetscape.

3.8 MECHANICAL AND UTILITY EQUIPMENT

A key goal of local designation is to preserve the historic appearance of individual buildings and the sense of scale and materials throughout a historic district. Mechanical and utility equipment can be one of the most visually intrusive additions to a historic district; however, modern building systems—such as mechanical, electrical, and plumbing systems—provide necessary functions that keep historic properties livable and comfortable. Building utilities should be installed sensitively with minimum visual and physical impact.

Advancements in technology and the integration of sustainable design practices have become part of the on-going conversation within the realm of historic preservation. Prompted by the desire to be energy and cost efficient, many property owners are eager to incorporate new heating, cooling and ventilation systems (HVAC) into their existing and historic buildings.

This section addresses mechanical and utility equipment, understanding that these building systems are desirable and necessary modern conveniences but need to be sensitively incorporated into an existing building. These systems require attachment to historic exteriors and penetration through historic materials. Therefore, they must be evaluated for their cumulative impact on a historic building and its surrounding context. The guidelines for Roofs and Exterior Envelopes are relevant to mechanical work and should be consulted in project planning.

Changes both big and small can have a significant, cumulative impact over time. Care must be taken to avoid the incremental loss of integrity during any systems upgrade on historic properties. A thoughtful approach to the systems upgrade should respectfully retain the historic fabric, consider integration of new systems to be reversible and understand the life-cycle benefit of the upgrade work toward the long-term preservation of the existing building.

The following guidelines are grouped by general system or design concern for clarity. It is understood that mechanical equipment technologies continue to evolve, especially those that strive to improve energy efficiency. **The guiding principles of minimal visibility, sensitive screening, limited penetrations, and reversible installation will hold true regardless of the product or system.**

Applicants are encouraged to communicate with design professionals, contractors or equipment installers, and public utility departments when planning and installing a new system. They should work with homeowners to create an appropriate solution.

HVAC SYSTEM DESIGN GUIDELINES

3.8.1 Limit the number of roof and wall penetrations when designing and installing new HVAC systems. Penetrations, whether located on a roof or exterior wall, increase the risk of water infiltration and damage to the building envelope. Properly flash and waterproof all penetrations.

3.8.2 For mini-split or wall-mounted systems, place wall-penetrating units on rear or non-visible façades. Place units at grade adjacent to rear or non-visible façades. Place systems, piping, and ductwork inside if possible.

3.8.3 Screen mechanical units at grade with landscaping features or historically appropriate fencing if units cannot be placed out of view from the street.

3.8.4 Install equipment, dunnage, and related mounting systems in the least invasive method feasible so that the alteration is reversible in the future.

3.8.5 Place rooftop mechanical units away from the primary façade and views from the public right-of-way. Minimize visibility of the entire system to the greatest extent possible. Conceal units behind existing roof features such as rear roof slopes or chimneys without causing damage to historic fabric. Select small and low-profile units for mechanical equipment that must be placed on the roof, if possible. Keep the height of dunnage beams (to support the mechanical units) low and no more than 8-12 inches above the roof surface.

3.8.6 Avoid altering roof shapes or configurations or slope pitches to accommodate roof-mounted equipment. Avoid altering or removing roof features such as chimneys or dormers. Mechanical systems should be designed around the existing roof.

TYPES OF HVAC SYSTEMS

Alternative heating, ventilation, and air conditioning systems offer modern conveniences and improved comfort. In some cases, these can use solar power to operate, helping to reduce their carbon footprint. Often integrating these newer technologies into existing and historic buildings can be challenging due to low clearances and ceiling heights and the limitations of the existing construction without wall cavities or chases to run ductwork and piping. The following are recommended HVAC systems that can successfully be integrated with limited impact to the historic fabric of existing structures.

» **Ductless heat pump:** also known as mini-split systems, are versatile and efficient cooling and heating systems that can be accommodated within existing building fabric and specifically within historic spaces which may contain low ceiling clearances, little to no space between the exterior wall and the interior finishes as well as decorative ornament and wood paneling. Heat pump systems include small sized condensers that can be remotely located on the exterior, piped to internal units that can stand alone or can be discreetly located and ducted. The exterior units can be mounted on secondary façades or at the ground level, screened with plantings, knee-walls or fencing where appropriate. Heat pumps are powered by electricity (which can be supplied through solar power) making them an environmentally friendly and preferred alternative over fossil fuel powered systems. There are 3 types of heat pumps including air-source, geothermal and a combination thereof. The principles and equipment behind all three are virtually the same, the source of power is what differs.

» **Radiant heating (walls and floors):** this system supplies heat directly to the floor or panels in the wall or ceiling transferring heat to the surface. Radiant heat is more efficient than forced-air and baseboard type heating systems because it is spread evenly through the spaces and there are not dead spots or duct losses for air to escape. There are two types of systems, electric and hydronic-liquid based, each having their own advantage. The electric system consists of electric heating cables built into the floor, powered off the electrical grid or through solar power while the hydronic system which pumps hot water through tubing laid in a pattern under the floor powered by a gas or liquid propane-fired boiler. Both systems can be operated from energy efficient power sources with small compact equipment internal to the building. This type of system is laid beneath the floor surface, which requires removal and reinstallation of the flooring in the case of an historic and existing building retrofit.

» **Forced air & central air:** Forced air systems provide heating and central air systems provide cooling. The heating component is powered by a gas or propane fired furnace and the cooling is powered by electricity. The heating and cooling are distributed through a ducted system. Forced air systems require space in the interior for the furnace and space to conceal the ductwork which can be challenging to retrofit in historic and existing buildings. Additionally, the compressor required is located on the exterior of the building, creating a visual impact which can be screened with landscaping, knee-walls or appropriate fencing.



Screening equipment with landscaping and placing units far back from the street helps preserve the historic streetscape, even at modern buildings. A concealed condenser unit is circled.



Mechanical units and generators should be placed on the rear façade, even if they are visible from secondary alleys.

INFORMATION FOR APPLICANTS

Applicants should submit HVAC manufacturer’s product information or technical specification sheets to HARB. Support materials should show product dimensions and appearance. Plans, sketches, or annotated photographs should clearly show the locations of unit(s), vents, and all associated pipes, wiring, mounting equipment, and/or enclosures.

VENTING & EXHAUST PENETRATIONS DESIGN GUIDELINES

New roof penetrations are sometimes necessary for items such as plumbing vents, gas risers, and laundry machine exhausts. Many buildings will already have some penetrations from existing building systems. Active (mechanical) air circulation and venting for interior spaces such as attics may require installation of vents into the roofing and eave assembly; adding vents to allow for passive air circulation (without mechanical air conditioning) can also be an appropriate treatment. These types of vents include ridge vents, soffit vents, gable vents, or turbine vents. For utilities located in a basement, pipes and vents located at grade level may be necessary for functionality. This can result in a group of gooseneck pipes that are incongruous with the streetscape.

3.8.7 Inspect existing roof and wall penetrations to ensure they remain watertight. Repair or replace flashing as necessary. A roof repair or re-roofing project is an ideal time to assess the condition of existing penetrations or to coordinate the installation of new penetrations in order for flashing and waterproofing to be seamlessly integrated into the roof system.

3.8.8 Limit the number of new penetrations when designing a new or updated system.

3.8.9 Minimize the visibility of mechanical vents and penetrations from primary façades and from the public right-of-way. Locate rooftop vents and penetrations on rear roofs, rear or non-visible roof slopes, or conceal behind chimneys. Minimize the visibility of vents or wall penetrations through sensitive placement, material and color selection, and painting vents to match the mounting surface. Place ground-level pipes and vents in rear yards and along non-visible façades, or screen with fencing or landscaping.

3.8.10 Reuse existing lines and vents when designing or upgrading the system, if there is sufficient capacity. Using existing vents reduces the disturbance of historic materials and avoids unnecessary penetrations in the building envelope.

3.8.11 Select low profile ridge vents when possible to minimize visibility and blend into the surrounding historic fabric. Ridge vents in a color or finish to minimize contrast with the roofing material are encouraged. Avoid tall passive vents that protrude from the roof, such as turbine vents.

3.8.12 For soffit vents, select narrow vents with paintable surfaces to minimize impact to historic eave appearances.

Thin rectangular soffit vents can be continuous or interspersed along an eave as necessary. Round soffit vents are available but are more visually intrusive.

3.8.13 Shield open vents to prevent rainwater from entering the building with appropriate low profile caps or associated fittings.

3.8.14 Avoid introducing new ventilation to unoccupied spaces without frequent air circulation that were not designed for occupancy (such as below a small turret roof). Ventilation in this case can lead to moisture infiltration, condensation and deterioration of historic materials.

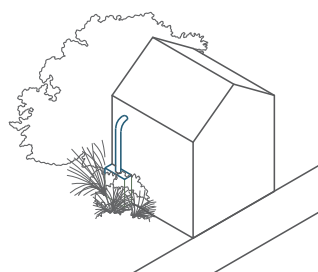

✔ Use greenery, landscaping, or enclosures to mitigate visibility of all utility and HVAC systems.

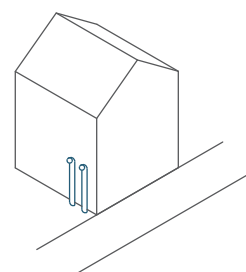

✘ Avoid placing vents (like gooseneck exhaust pipes) on visible façades or near streets.

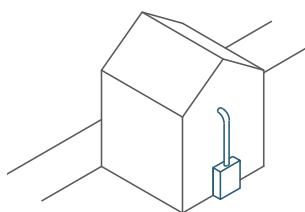

✔ Locate HVAC systems on the rear façade or where equipment is not visible from the street.

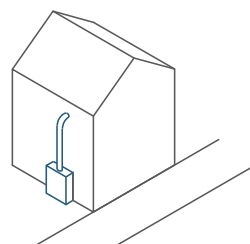

✘ Avoid locating HVAC systems close to the street or main façade.

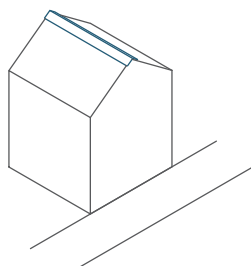

✔ Appropriate ridge vents are low-profile and integrated with roof material and flashing

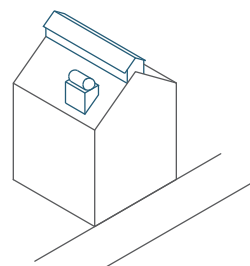

✘ Prominent ridge vents and large stand-alone vents are not appropriate

UTILITY METERS & WIRING DESIGN GUIDELINES

This section concerns the installation of gas and electric meters, power lines and electricity wiring, conduits, and miscellaneous equipment for any building utilities.

3.8.15 Install all meters and wiring in a location that minimizes visibility from the street. In cases where equipment and wiring cannot be completely obscured from view, set installations back from the street and reduce visibility to the greatest extent possible. Installation of equipment, meters, or wiring on a primary façade is never appropriate. Consult with a public utility representative to determine alternative locations for meters. Locate equipment in a basement or on rear façades whenever possible.

3.8.16 Screen meters with appropriate fencing or landscaping, provided utility access requirements are met.

3.8.17 Paint meters and wiring encasements the same color as the surface behind them.

3.8.18 Consolidate electricity wiring with other telephone, cable, or similar wiring whenever technically feasible and string to a single point on the building.

3.8.19 Conceal exterior wiring to the greatest extent possible. Run wiring into a building interior rather than string wiring along the exterior walls. When wires are unable to be run inside, run along unobtrusive edges such as the corner of the building and along the eaves.

3.8.20 Encourage removing excess wiring or equipment that are no longer in use to avoid visual clutter. Avoid low hanging wires for public safety. Removals should only be conducted by the public utility company or qualified professionals.



Even if utility meters cannot be completely hidden, they should be placed on rear or secondary façades. Coordinate with the public utility installer to place meters in an appropriate location and use paintable enclosures.

GENERATOR DESIGN GUIDELINES

Installation of generators has increased in Milford. This work shall follow the same principles of minimal visibility, sensitive screening, limited penetrations, and reversible installation.

3.8.29 Locate generators at rear façades or in rear yard and minimize visibility from the streets.

3.8.30 Conceal generators with appropriate fencing or landscaping.

SOLAR ENERGY DESIGN GUIDELINES

Solar collectors (in other words, solar panels) are the most widely available products for renewable building energy. As with other exterior-mounted systems, the design objectives of minimal visibility, sensitive screening, limited penetrations, and reversible installation apply. The guidelines are geared towards solar panels but are applicable to any new alternative energy system: balance the functional benefits of a new system with sensitive treatment of the historic building. Creative solutions can almost always be developed to achieve both energy efficiency and preservation goals.

3.8.21 Conduct an energy audit to understand the building's thermal performance. This helps the new system perform most efficiently and can identify other minor building repairs to reduce energy loss.

3.8.22 Preserve the historic character and materials of a building when planning a solar energy system. Avoid removing or altering character-defining features.



Grouping meters on a secondary façade and painting reduces the immediate visual impact.

3.8.23 Minimize the visibility of solar panels, mounting equipment, and conduits, meters and junctions boxes from the street. Locate solar collectors on rear roof slopes. If only side roof slopes are technically feasible, locate collectors as far back from the street as possible.

3.8.24 Design solar panel arrays in uniform and rectangular arrangements.

3.8.25 Install panels to ensure that if removed in the future, there will be no damage to the building's historic fabric and details.

3.8.26 Install solar collectors or equipment as flat as possible to the surface where they are installed. Design panels with a shallow projection/profile from the roof plane.

3.8.27 Choose energy systems, mounting equipment, and necessary mechanical equipment in a color compatible with existing roof materials and with non-reflective finishes.

3.8.28 For architecturally integrated solar systems, choose low profile shingles in a compatible and non-reflective color. Match the historic size and pattern as closely as possible. Such systems include solar shingles or integrated standing seam metal roofs. Systems will be evaluated on a base-by-case basis based on visual impact and physical characteristics.

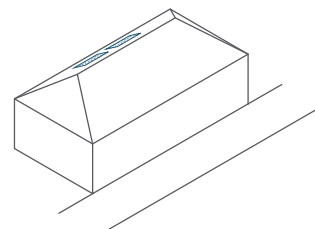

Place panels on least visible roof slope possible. Set panels back from roof edge to minimize visibility.

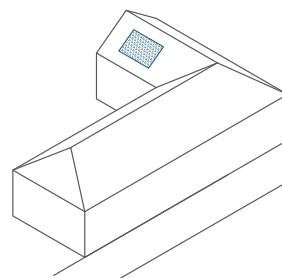

Locate solar panels on the roofs of side façades toward rear of the property.

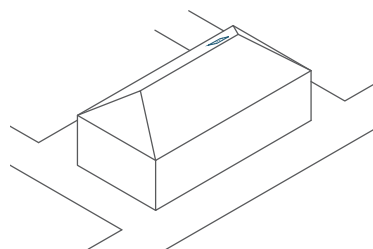

If there is a secondary street, locate solar panels on upper corners of the "rear" roof slope.

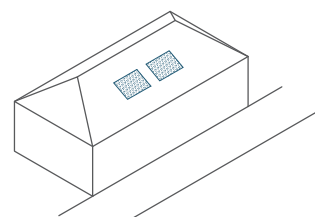

Avoid locating solar panels on the roof facing the street or main façade without appropriate screening.

TECHNOLOGY CONSIDERATIONS

Solar energy systems are a rapidly evolving technology. New products are expected to increase in availability and design. It benefits all Milford residents to evaluate commercial claims about efficiency, conduct performance monitoring, and consider when new systems may be appropriate for use within the historic district. Milford and the State of Pennsylvania encourage the use of renewable energy systems.

Applicants are encouraged to bring questions about new products to HARB.

USEFUL LINKS

For in-depth guidance on sustainability strategies that comply with the Standards for Rehabilitation, refer to the [National Park Service's Illustrated Guidelines on Sustainability for Rehabilitating Historic Buildings and Solar Panels on Historic Properties](#).

3.9 TECHNOLOGY & EQUIPMENT

Information technology systems are complex and ever-changing and require accessible routes for wiring. Such systems include internet, television, and telephone, with new technologies for “smart” buildings developing quickly. This section addresses technological devices that are attached to a building yet are not part of a building system, such as heating or plumbing. The guiding principles of minimal visibility, sensitive screening, limited penetrations, and reversible installation will hold true regardless of the type of equipment. The need to incorporate communication technologies must be sensitively done to achieve a balance between preservation objectives and modern convenience and functionality.

SATELLITE DISH DESIGN GUIDELINES

3.9.1 Locate satellite dishes on non-visible façades and rear roof slopes so they are not visible from the primary public right-of-way.

3.9.2 Avoid mounting satellite dishes on historic materials. Install in the least intrusive manner feasible so the alteration may be reversible in the future.

SECURITY DEVICE DESIGN GUIDELINES

3.9.3 Conceal exterior devices as much as possible. Security cameras and similar devices at secondary entrances and façades is preferred to minimize visibility from the public right-of-way. If placement on a primary façade or highly-visible façade is unavoidable, place devices in the most concealed location possible.

3.9.4 Avoid mounting devices on historic materials, such as door trim or transom windows. Install in the least intrusive manner feasible so the alteration may be reversible in the future. Removing architectural features or historic hardware to accommodate the installation is not appropriate.

3.9.5 Select equipment in a color that matches or is compatible with the building’s color scheme in order to visually blend the device with the surface upon which it is mounted. Paint devices and conduits to blend in if the surfaces are paintable.

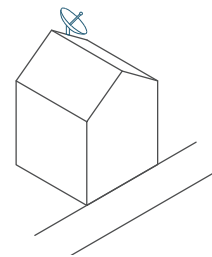

Locate satellite dishes in non-visible areas of the roof or on rear façades

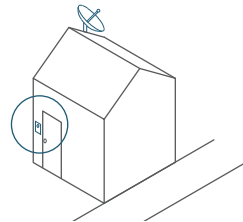

It is best to locate security cameras and similar devices at secondary entrances to minimize public visibility

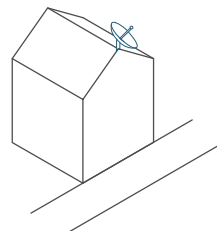

It is not appropriate to install a satellite dish on the main or front roof line of a property

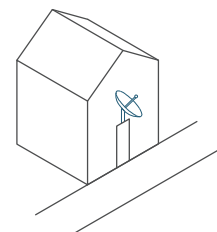

A satellite dish should not be mounted on features like doors, windows, or cornices



Satellite dishes on rear roof slopes can be almost entirely concealed from the public right-of-way.



Satellites should be placed on rear roof slopes to minimize visibility from the main street. It may be unavoidable that satellites are visible between buildings on other streets, but the immediate visual impact is reduced.



Security and communication equipment should be placed to minimize visibility. It may be unavoidable that equipment will be visible, but the immediate visual impact may be reduced through color and low profile options.

INFORMATION & COMMUNICATION WIRING DESIGN GUIDELINES

These guidelines apply for general wiring and exterior components of information technology, and overlap with the guidelines for electric utilities.

3.9.6 Consolidate wiring for information and communication technologies with electricity wiring whenever technically feasible and string to a single point on the building.

3.9.7 Conceal exterior wiring to the greatest extent possible. Run wiring into a building interior rather than string along the exterior walls. When wires are unable to be run inside, run along unobtrusive edges, such as corner boards, skirt boards or water tables above the foundation, or under eaves. Paint wires the same color as the surface they run along.

ELECTRIC VEHICLE STATION DESIGN GUIDELINES

Installation of electric vehicle charging stations is an emerging question for historic districts in many communities. Even if they are not common in Milford today, questions of appropriate installation are likely to come in the near future.

3.9.8 Install exterior electric vehicle charging stations in the least visible location possible. Typical charging stations are mounted to exterior walls or stand-alone posts. Place stations at rear façades or far back from the street on side façades. It is not appropriate to install equipment on primary façades or corners adjacent to the street.

3.9.9 Attach wall-mounted charging stations in such a way that minimizes damage to historic materials and can be reversed in the future.

3.9.10 Screen charging stations with landscaping and/or enclosures. Paint post supports and enclosures blend into the building or in a dark natural color to blend into landscaping, whichever color is least visible.

3.9.11 Conceal all cords and conduits from view.

3.10 ACCESSORY STRUCTURES

Accessory structures are broadly considered to be non-habitable outbuildings that are located on a property and are subordinate to the main building, such as detached garages and sheds. Accessory structures are part of the district's main streetscape and its grid of secondary alleys. Flexibility for adaptive reuse of historic accessory structures and the appropriate preservation treatments can depend on the history and significance of the particular structure. In general, accessory structures should respect the primacy of the main building.

CONTRIBUTING & NON-CONTRIBUTING STRUCTURES

A contributing accessory structure is considered to be one that was built at the same time as the main building; was an early addition to the property and built within the district's period of significance; or was functionally related to the building and its reason for significance. Many structures were designed with the same style, details, and materials as the main building. Contributing structures are part of the historic district's streetscape and they should be preserved with the same care as the main building.

Non-contributing accessory structures were constructed later or may have been significantly altered over time, and even if they were original, they no longer retain historic integrity. Just because a structure already exists in the historic district does not mean it is appropriate or should be emulated in future work. Greater flexibility for alterations is appropriate. Non-contributing structures can tolerate a higher degree of intervention, since they have little to no historic fabric to be impacted. However, proposed changes must still be considered carefully as they can impact the surrounding historic district.

MAINTENANCE RECOMMENDATIONS

3.10.1 Preserve and retain existing historic accessory structures in their original location, scale, design, and materials. Conduct periodic inspections of roofs, drainage systems, and exterior envelopes as would be done for a main building.

DESIGN GUIDELINES

3.10.2 Repair and restore existing materials and building features. Attempt to repair and reuse existing materials before considering removal and replacement. Notable features include original doors (in their appearance, type of operation, and materials), roof shape, and exterior envelope materials.

3.10.3 Replace deteriorated materials or features in-kind. Replacements should match the original in material, profile, size, dimension, texture, and appearance.

3.10.4 If in-kind replacement is not feasible because of the material(s), alternate materials may be appropriate if the replacements match the original in size, profile, dimension, texture, appearance, and finish as closely as possible. Appropriate alternate materials should follow the guidelines related to the main building's materials.

3.10.5 For rehabilitation or adaptive reuse, preserve the original character of accessory structures. Conversion for a new use may be appropriate in some cases, if the conversion does not result in substantial changes. Such projects must also comply with all zoning requirements and similar codes.

3.10.6 Retain existing height and massing of the structure. Avoid altering the overall proportions of the building. Minimize any enlargement of, or addition to, accessory structures. Accessory structures should remain subordinate to the main building. Minimize visibility of the addition from the street. Enlargements and additions should be compatible with the existing in massing, scale, proportion, rhythm, and materials.

3.10.7 Avoid relocating original accessory structures to new areas of a property. Altering a structure's spatial relationship to the main building or other site features is not appropriate.

3.10.8 Demolition of existing accessory structures should only be considered for non-contributing structures.

3.10.9 Avoid adding features or details that never existed on the structure. It is not appropriate to alter an accessory structure just to match the main building; this action may convey a false sense of the property's historical development.

3.10.10 Where existing accessory structures are not original to the property, are not considered an alteration or addition that has gained significance in its own right, or have

been altered to such a degree that they no longer retain historic integrity, more flexibility in design and material may be appropriate. Alterations should respect the main building in architectural style, proportions, and appearance.



Contributing accessory structures are contributing resources to the district and have character-defining features of their own.



Continuity of design and materials between a main building and a contributing accessory structures add to the character of the district.

INFORMATION FOR APPLICANTS

Although the HARB does not review changes to landscaping, paving, or driveway materials—changes that may occur as part of an accessory structure project—property owners are encouraged to use compatible materials and respect the visual and spatial relationship between the main building and accessory structure.

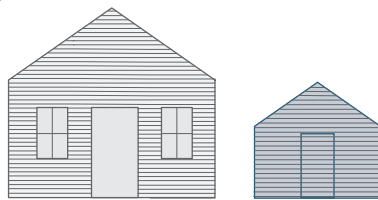

Repair and restore existing materials and building features before considering removal or replacement. This includes doors, roof shape, and exterior materials.

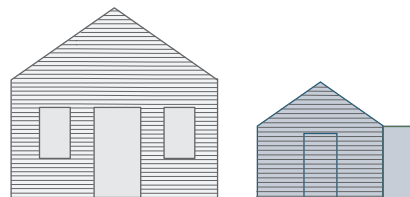

Adding features or details that never existed on the structure. This can potentially convey a false sense to the historical development.

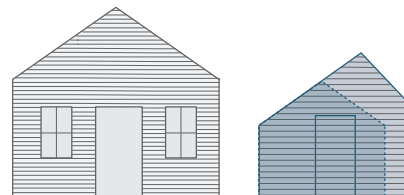

Altering existing height and massing of the structure. Accessory structures should remain subordinate to the main building.

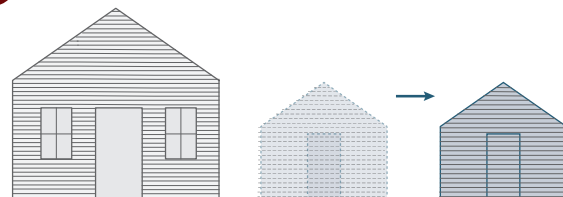

Moving or relocating original accessory structures to new areas on the property changes historic spatial relationships.

Refer to [Chapter 4: Guidelines for New Construction](#) for guidance on constructing new accessory structures.

3.11 FENCES & STREETSCAPE FEATURES

Fences can contribute to the visual character of the streetscape, especially when they are located in front of primary and highly visible façades. Wood and wrought iron are the most common historic fencing materials. Historic fences should be preserved and treated as character-defining features of the individual building and surrounding historic district. Fences, historic and new, should not detract from the architectural character of the building or of the streetscape in the historic district. Other outdoor features should also minimize impacts on the streetscape.

DESIGN GUIDELINES

3.11.1 Repair and restore historic fences. Preserve all fence components including vertical balusters or spindles; horizontal members including caps and rails; intermediate and end posts; and stone curbs. Repair work may also include localized replacement of severely deteriorated or missing components with in-kind materials.

3.11.2 Replace existing historic fences in-kind if repair is not feasible due to deterioration. New fences should match the original as closely as possible in materials, profile, appearance, and height. The proportion of fence components relative to each other and the transparency of the fence should be replicated. Avoid reducing the visibility of a historic building or infilling sections with opaque materials.

3.11.3 If in-kind replacement is not possible, alternate replacement materials may be acceptable if they match the original in size, profile, and exterior finish. Painted aluminum is an acceptable alternate.

3.11.4 For new fences at primary façades, select designs that complement the architectural style of the building and have high transparency. Appropriate fence types include picket, capped picket, and spindle (wood or iron). Size and spacing should follow historic and local precedents. Spindles may be square or round, with simple or decorative ends. Ornate metal balusters with scrollwork or dense cast iron details are only appropriate if such designs are original to the building. Simple and discreet designs are preferred when the original fence appearance is unknown.

3.11.5 For new privacy fences or screening for mechanical equipment and similar exterior items, select simple designs that respect the primary of the historic building. Allow for transparency whenever possible and minimize the amount of opaque area to the greatest extent possible. Appropriate fence types include capped flat board, lattice, and flat board with lattice panels.

3.11.6 Match the height of new fences to the height of nearby fences. New primary fences should be low and should not obscure the view of the building. New privacy fences or screens should not exceed the necessary height to conceal rear yards or systems equipment. Avoid excessive height that negatively impacts the pedestrian experience on the sidewalk and is out of proportion with the rest of the neighborhood.

3.11.7 For non-original or previously-altered fences, consider restoring the original fence appearance (if documented) or replacement with a simple appropriate design. In-kind replacement of non-historic fences or existing inappropriate designs is not encouraged.

3.11.8 Avoid chain-link fences, PVC (vinyl or plastic) fences, split-rail or ranch-rail fences, shaped metal rod fences from modern stock profiles, or similar non-historic alternate materials and styles.

3.11.9 Avoid removing historic fences unnecessarily to create driveways, off-street parking, site improvements, or similar. This alteration impacts the rhythm and visual continuity of the streetscape.

INFORMATION FOR APPLICANTS

In the application, define the goal of the fence: is it a decorative fence at the primary façade or intended as a privacy fence? Clearly show its proposed location. Fences at primary façades have different review considerations from side or rear yard fences.

TYPICAL FENCE ANATOMY

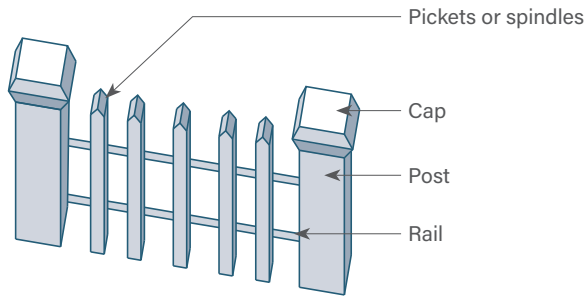

EXAMPLES OF APPROPRIATE FENCING



Wood picket fence



Cast iron fence with ornamented posts



Capped flat board privacy fence

FENCE DESIGNS

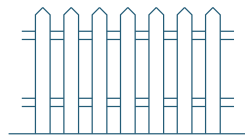

Picket

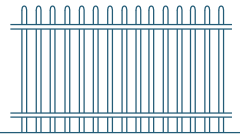

Spindle (wood or iron)

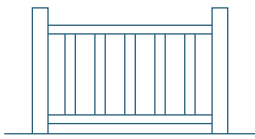

Capped Picket with Exposed Posts

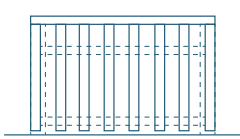

Capped Picket with Concealed Posts & Rails

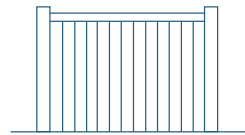

Capped Flat Board with Exposed Posts

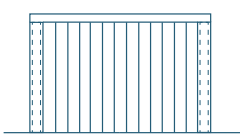

Capped Flat Board with Concealed Posts

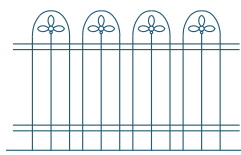

Wrought Iron

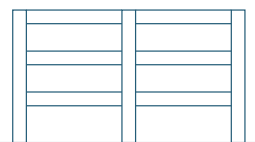

Ranch Rail / Split Rail

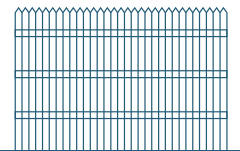

Stockade

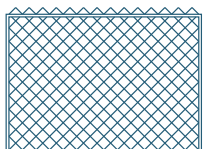

Chain link

BEFORE	AFTER	
	✓	✗
		
	Repair and restore in-kind when there is visible deterioration. Retain original openings and visibility of main building.	Obscuring the historic building with new fencing is not appropriate.
		
	Maintain historic fences along the sidewalk. Gates should be blended into the existing fence if off-street parking is necessary.	Avoid removing historic fences to create driveways or off-street parking.
		
	New fences should match or be similar to the height of nearby fences.	New fences should not be taller than existing fences.
		
	Match existing profile and size when making localized replacements.	It is not appropriate to use a different picket size and style when making localized replacements.

SITE LIGHTING GUIDELINES

3.11.10 Retain and preserve historic lighting fixtures. Repair, restore, and reuse historic fixtures whenever possible, as these contribute to the historic character of the building. Keeping historic fixtures in original location is the most appropriate. If they cannot be retained in place, relocate fixtures to allow for reuse.

3.11.11 Replace in-kind if historic fixtures are severely deteriorated and cannot be repaired. New fixtures should match the original as closely as possible in size, style, material, finish, and appearance.

3.11.12 If in-kind replacement is not feasible or new fixtures are being installed, select new fixtures that are compatible with the scale and style of the building and its primary façade components (usually windows and doors). Small, simple, and discreet designs are generally the most appropriate.



This example shows an appropriate approach for lighting replacement that mirrors the building's architectural style and its construction period.



Lights that match the historical period of the building are appropriate for main façades.



Avoid installing lights that are out-of-date with the architectural style of the construction.

3.12 COMMERCIAL STOREFRONTS

Milford's historic district is primarily commercial buildings that contribute to the district's vibrancy. Many buildings originally constructed as residences were later converted for commercial use. Original storefronts and compatibly-designed alterations contribute to the area's historic character and support a pedestrian-oriented streetscape. Preservation of primary façades maintains interest at the street level and contributes to the rhythm of the street. The overarching design objectives are to preserve remaining historic storefronts, restore inappropriately altered storefronts, and design compatible new storefronts.

DESIGN GUIDELINES

3.12.1 Repair and restore existing features of historic storefronts. Avoid removing, destroying, or obscuring character-defining storefront features. The retention and preservation of these features, as well as the scale and massing of the storefront, should guide any alterations.

3.12.2 Preserve the historic proportions of the storefront and façade, such as the location of the entrance, the size and number of display windows, configuration of display windows and transoms, and recessed entrances.

3.12.3 Repair and restore storefront transom windows. Transom windows (the upper portion of traditional storefronts) contribute to visual unity across a block face and allow more daylight to the interior. Transom windows should not be removed, covered, or enclosed. Retain the dimensions of the historic transoms. Retain historic glass or lite patterns.

3.12.4 Replace in-kind any materials, features, or components of storefronts that are irreparably damaged or missing. In-kind replacements should match the original in material, size, profile, and appearance.

3.12.5 Retain any elements of the historic storefront uncovered during the course of a project. Original materials sometimes remain intact underneath later alterations and additions.

3.12.6 Consider restoring transom windows if the original windows are no longer extant and sufficient historic documentation is available.

3.12.7 Consider reversing past alterations that are not consistent with the original design or were made after the building's period of significance. Consult available documentation such as historic photographs to inform the restoration of a façade.

3.12.8 Where a historic storefront is no longer extant or a new storefront is planned, consider an alternative design that is a contemporary interpretation of the historic storefront. Reference the surrounding context and related architectural style of the building with regards to proportion, placement, and scale.

3.12.9 If historic materials no longer exist but the appearance of the historic storefront is documented in photographs or drawings, consider reconstruction or honoring its proportions and configuration in the new design. It is not required to recreate the storefront exactly. Reconstruction is an option, if there is enough evidence, or the historic appearance can inspire the new design.

LIGHTING GUIDELINES

3.12.10 Use sign illumination and lights that are simple and complement the historic building and district. Simple gooseneck lights mounted above the sign are recommended as historically appropriate shape and profile.

3.12.11 Direct lighting toward the sign and avoid excessive illumination of areas outside of the sign. Uplighting is not appropriate.

3.12.12 Attach light fixtures that are not integrated into the sign in a method that does not damage historic materials or features.

USEFUL LINKS

For more sign information, refer to the Signs section of the [Milford Zoning Ordinance §312-14](#)

For additional guidance, see National Park Service, [Preservation Brief #11 Rehabilitating Historic Storefronts](#)

Commercial Storefronts Features: Signage

Historically Milford's commercial buildings used signs shape, lettering, and location as primary elements to identify businesses and attract customers. Signage is an important and usually necessary aspect of commercial activity within a historic district. In a historic district, signs should respect the architectural character of the individual building and the rest of the block. All signage must also comply with the Zoning Ordinance.

DESIGN GUIDELINES

3.12.13 Repair and restore original or historic signage whenever possible. Replace in-kind if materials are severely deteriorated. It is rare that original or historic signage remains intact within the historic district today, but any example should be preserved.

3.12.14 Locate new signs in historically appropriate locations, such as the sign band directly below a cornice or the ends of a façade.

3.12.15 Reuse existing hardware, supports, and brackets if possible to reduce the number of new holes created in exterior walls. Patch and repair holes or similar damage caused by previous signs installations.

3.12.16 Attach signs in a method that does not damage historic materials. For signs attached to a masonry façade, anchors should be placed in mortar joints, not in the masonry unit. Installations should be reversible and should only require minor repairs or patches if removed in the future.

3.12.17 Scale signs to be compatible with the proportions and scale of the storefront and building. Compatible proportions should minimize the visual impact of the sign when looking at the building or streetscape. Small signs are usually the most appropriate. The size of signs and lettering should prioritize pedestrians rather than vehicles. Text heights between 6 and 12 inches is generally recommended.

3.12.18 For wall or projecting signs, use simple shapes and profiles such as ovals and rectangles. Shaped signs that relate to the business use may be appropriate on a case-by-case basis but are usually not recommended.

3.12.19 For projecting signs, use brackets that are simple in design and profile. Single rods and scrollwork are both historically appropriate. Metal brackets with black painted or coated finishes are the most appropriate and minimize the visual impact to the building and street.

3.12.20 For window signs (surface-applied or painted), maintain the transparency of the window by using lettering and/or logos without a solid background. High transparency lettering and window-applied signage helps to minimize the visual impact to the building and street. Solid backgrounds are not encouraged but are not prohibited. An advantage of window signs is that they are easily reversible and do not damage historic materials.

3.12.21 Design signs to complement the architectural character of the building and the surrounding historic district. Individual expression and creativity are encouraged while respecting the primary of historic character. Simple fonts are recommended and both serif or sans serif fonts can be appropriate. Use colors that promote legibility and complement the building's existing color scheme; muted tones, colors found in nature, white, and black are generally appropriate. Avoid excessively ornate fonts, a mix of many different fonts, and bright, neon, or high-contrast color schemes.

3.12.22 Coordinate the fonts and color palettes used if multiple signs are proposed for an individual building.

3.12.23 Use high-quality and durable materials. Wood was the most common historical material, especially projecting and hanging signs, and is appropriate but not required. Composite wood, metal (for signs and brackets), applied vinyl letting and painted lettering are also appropriate materials. Applicants may propose other materials for the HARB's consideration.

3.12.24 Comply with all Zoning Ordinance requirements including those related to number, size, and location of signs.

3.12.25 Avoid covering or obscuring architecturally significant or distinctive features. Removing or destroying historic elements for the purpose of installing a sign is not appropriate.

COMMERCIAL STOREFRONTS CONFIGURATION & SIGNAGE TYPES

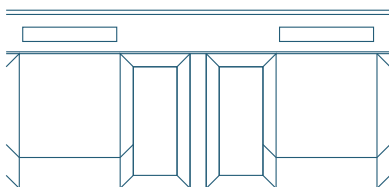

✔ Storefronts should maintain their original layout and existing façade components and materials.

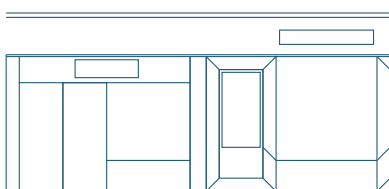

✘ It is not appropriate to disrupt the façade with alternative proportions or materials that do not match cohesively with the rest of the property.



✔ Halo lit (behind)



✔ Projecting above (goose neck)



✘ Projecting below (uplighting)



Storefronts are part of Milford's historic character, especially along Broad Street.

3.13 ACCESSIBILITY & CODE-REQUIRED WORK

The primary design objective for accessibility and code-required improvements is to provide safe, respectful, and equal access in historic buildings, sensitively altering so that they are physically accessible to all. This chapter contains guidelines for accessibility improvements and proposed work required for code compliance or undertaken voluntarily. The chapter is then divided into work categories to provide specific recommendations where applicable. The overarching design objective for these improvements is to provide safe, respectful, and equal access in historic buildings.

Sensitively altering historic buildings so that they are physically accessible to all is a desirable goal. Often alterations to original materials are required to create barrier-free access. Barrier-free access can be required from a life safety/emergency egress perspective and a universal accessibility perspective. Exterior ramps, lifts, landscape work, site regrading, and entrance changes are common solutions.

There is no one solution for incorporating barrier-free access in historic buildings. Staff and the HARB can assist property owners in developing appropriate solutions or alternatives. An appropriate solution can almost always be devised that achieves a project's needs while minimizing impacts to the historic building. Cost, technical feasibility, and integrity of historic fabric will be considered by HARB in evaluating options.

PROJECT PLANNING GUIDELINES

3.13.1 Define the projects goals. Define the project parameters that are required to achieve building code and accessibility code compliance. Understanding the goals and requirements will help applicants, Staff, and the HARB evaluate appropriateness.

3.13.2 Conduct an assessment of the building in order to determine code deficiencies and to establish a hierarchy of historic fabric. This hierarchy should distinguish historic fabric or spaces that are priorities for preservation, fabric that can tolerate minor alteration, and areas of opportunity for major interventions. This type of assessment is typically performed by an architect or other professional consultant.

DESIGN GUIDELINES

3.13.3 Identify character-defining features and original materials so that work will not result in their damage or loss. Retain historic materials, building elements, and features.

3.13.4 Design and construct modifications in such a manner that they do not destroy, remove, or obscure (within reason) historic materials. Consider provisions for reversibility so that modifications can be easily removed without damaging historic fabric in the future.

3.13.5 If an addition to a building is planned, consider incorporating work into areas of new construction rather than areas with historic materials.

3.13.6 Select exterior finishes that match the historic building or are visually compatible, or paint new features without causing damage to the underlying material.

3.13.7 Document historic and existing materials in the area of proposed work prior to construction in photographs and/or drawings. Submit documentation to Staff to include in the property file.

3.13.8 If adding handrails to historic properties becomes necessary in order to address accessibility and life safety issues, design simple handrails that do not detract from historic railings and so they do not detract from the character-defining features of the property. Simple wood or metal railings are appropriate options.

ACCESSIBILITY DESIGN GUIDELINES

The Americans With Disabilities Act is a civil rights law enacted in 1990 prohibiting discrimination against persons with disabilities and ensuring equal opportunity for them in public accommodations, commercial facilities, transportation, employment, and government services. The United States Access Board is responsible for developing and updating the ADA guidelines that State building codes enforce; the current publication is the 2010 ADA Standards for Accessible Design. Pennsylvania's statewide Uniform Construction Code also adopts the International Building Code Accessibility Requirements.

To the fullest extent possible, property owners should comply with federal, state, and local provisions while

preserving the integrity of the character-defining features of their buildings and sites. Accessibility criteria for existing buildings are addressed in the 2010 ADA Standards for Accessible Design and the Pennsylvania Existing Building Code. There is additional flexibility for designated historic buildings. Where compliance with requirements for accessible entrances, circulation, or building features would significantly alter historic fabric or negatively impact the significance for which the building is designated, alternatives can be designed and permitted. Proposed repairs, alterations, additions, or changes in occupancy require a full review of accessibility requirements and options to establish technical feasibility. The objective shall always be to increase accessibility and barrier-free circulation wherever possible. Exterior ramps and lifts to provide building access are among the most common and most visible alterations for historic buildings.

3.13.9 Provide access through a primary entrance whenever feasible. The accessible route should be the circulation route used by the general public.

3.13.10 Retain original and historic doors, location and size of door openings, and hardware. If removal of doors is unavoidable, retain frames and jambs in place. Significant permanent changes to original doors, porticos, or stairs at a primary entrance are discouraged.

3.13.11 If use of the primary entrance is not feasible, provide at least one accessible entrance on a secondary façade, located close to the primary entrance.

3.13.12 Avoid rear or service entrances as the only accessible means of access.

3.13.13 Design alterations, modifications, and new entrances to be compatible with the building's architectural style and materials, and that are visually cohesive.

3.13.14 For accessible entrances not at the primary entrance, provide compliant directional signage that is visually cohesive.

3.13.15 Provide compliant thresholds, hardware, and similar details that are compatible with the historic building in appearance, material, and exterior finish.

3.13.16 Modify grade or walkway elevations as an option to provide an accessible entry and meet code requirements at ground level entrances. Minor grade changes may be practical in some cases and may offer an alternative to building alterations or exterior equipment.

MEANS OF EGRESS DESIGN GUIDELINES

Chapter 12 of the Existing Building Code of Pennsylvania established alternative paths to life safety compliance with altering historic buildings. Alteration projects that exceed a certain threshold of work may be required to comply with current building codes. "Building code" is used here as an umbrella term to encompass all state and municipal codes that regulate building safety including the building and construction codes, fire codes, and existing buildings or rehabilitation codes. Egress requirements are calculated by a building's maximum number of occupants (occupant load) and its use (such as residential, business, or educational). The number of entrances and exits impacts the number of occupants allowed. Minimum requirements differ according to use.

This type of work is especially relevant for multi-family residences, conversion of single-family residences into multi-unit residences, and adaptive reuse projects. The objective shall always be to ensure that all life safety and means of egress requirements are met while minimizing impacts to historic fabric and the visual character of the surrounding historic district.

3.13.17 Locate code-required egress stairs and life safety modifications on non-visible façades whenever possible.

3.13.18 Minimize visibility of egress stairs and life safety modifications from the street if a non-visible location is not possible.

3.13.19 Incorporate means of egress in a manner that minimizes impacts to the historic building and materials.

3.13.20 Keep code-required features to the minimum functional size.

USEFUL LINKS

For more information about addressing accessibility in historic buildings, see [National Park Service, Preservation Brief #32: Making Historic Properties Accessible.](#)

3.14 RELOCATION & DEMOLITION

Demolition of a historic building is an irreversible alteration and a detrimental loss to Milford's architectural heritage. Demolition of existing historic buildings or historic accessory buildings for the sole purpose of redeveloping the property with new construction is never appropriate. Demolition is never encouraged and can almost always be avoided through restoration, rehabilitation, relocation, and adaptive reuse. Relocation may be an alternative to demolition, evaluated case by case. The objective of a demolition review is to explore alternatives to demolition and ensure that due diligence has been conducted.

DESIGN GUIDELINES

3.14.1 Pursue alternatives to demolition before proposing demolition. Applicants are encouraged to work with Staff and the HARB on developing alternative solutions. Possible alternatives include preservation, restoration, adaptive reuse, relocation, or transfer to a new owner willing to rehabilitate the building.

3.14.2 Evaluate the significance of the building and its contribution to the historic district. Determine if the building has individual architectural, cultural, or social significance or is associated with significant people or events. It is recommended to reference the National Register of Historic Places' criteria for significance.

3.14.3 Determine if the building retains historic integrity. Evaluate the cumulative impact of past alterations. Buildings that have been altered to such an extent that they no longer convey their significance or contribute to historic district may have more flexibility in review.

3.14.4 Evaluate the impacts of the proposed demolition on the historic district. Evaluate the impacts to the adjacent buildings, the immediate surroundings, and the historic district as a whole.

3.14.5 Provide documentation that the feasibility of rehabilitation has been sufficiently investigated and alternatives to demolition have been explored. Documentation may include feasibility studies, professional conditions assessments, structural report by a licensed engineer, cost estimates, or similar due diligence. Documentation can be provided in written descriptions, photographs, drawings, and financial data.

3.14.6 Provide documentation that transfer of the building to a new owner was attempted and demonstrate efforts to find a buyer willing to retain and rehabilitate the building.

3.14.7 Consider architectural, structural, and economic feasibility factors. Demolition is not appropriate if due diligence demonstrates that there is an economically viable use, even if that use is not the "highest and best" use.

3.14.8 If demolition is proposed because the Building Inspector has declared a clear and present danger, provide official documentation with the application. The Building Inspector may determine that a building is in a state of collapse or has deteriorated to such a point that it is a public safety concern. This finding should be supported by documentation from a licensed structural engineer.

3.14.9 Avoid demolition by neglect through regular maintenance, repair, and restoration. Severe deterioration and poor condition that is the result of neglect can be considered a self-created hardship and is not an appropriate justification for demolition.

3.14.10 Consider contributing status. Buildings were constructed after the district's period of significance or are intrusive to historic patterns of material, design, scale, proportion, and massing may be reviewed for demolition with greater flexibility by HARB.

3.14.11 For accessory structures, determine if the structure contributes to the historic character of the building or block. Consider the relationship and historical connection of the accessory structure to the primary building. Demolition of existing accessory structures can be considered appropriate for non-historic structures that do not contribute to the historic character of the building or district or that detract from this historic character. Non-contributing status must be determined by the HARB.

3.14.12 For accessory structures, consider the structure's spatial relationship to primary streets, secondary streets, and alleys, and its overall visibility within the district. Structures located on primary streets will have greater visibility within the district. Demolition of structures located only on secondary streets and alleys may be appropriate because of its reduced visual impact, but must also be evaluated for contributing character.

3.14.13 Evaluate the potential impacts and appropriateness of proposed demolition first, regardless of proposed future development. It is appropriate that the HARB evaluate proposed demolition as a stand-alone project because the proposed plans for new construction may change. After the HARB has evaluated significance, integrity, and potential impacts, they may consider the contribution or impact of proposed future development to the district.

3.14.14 If demolition is pursued, salvage building features and historic materials that are suitable for reuse. Architectural salvage is a responsible environmental practice and is encouraged so that historic materials could be reused at other historic buildings. Demolition work must comply with all applicable codes and health and safety regulations.

3.14.15 If demolition is pursued, document the building thoroughly prior to demolition. Photographs and measured drawings (plans, elevations, sections, and details of unique features) or similar documentation should be submitted to Staff for inclusion in the property file.

HARB REVIEW

Proposed demolitions must be reviewed by the HARB. Applications must include relevant and specific information about the historic building or structure, the existing conditions, investigative assessments, the reason for the proposed demolition, and information about future use of the property. Support materials are critical for the HARB to make an informed determination of appropriateness. Due diligence must clearly demonstrate that rehabilitation is not feasible, and therefore demolition is the only feasible option.

The HARB may determine that the applicant has conducted sufficient due diligence and has made reasonable efforts to analyze alternatives to demolition. In making a recommendation to the Borough Council, the HARB may include conditions of approval.

DEMOLITION APPLICATION CHECKLIST

The following materials should be submitted for proposed demolition of Local Criteria Category A, B, and C buildings. Proposals for Category D buildings should focus on any new construction proposed.

- » Color photographs of all façades of the building, detailed conditions, and immediate surroundings. A key plan or map showing the photograph locations is recommended.
- » Site plan / property map.
- » Description of the building to be demolished and contributing/non-contributing status.
- » Description of the reason for proposing demolition.
- » If applicable, official inspection report or documentation declaring a clear and present danger at the property.
- » Documentation of evaluation of alternatives to demolition (including but not limited to feasibility studies, condition assessment, professional reports, and cost estimates).
- » Documentation of efforts to transfer the building to an owner willing to rehabilitate the building.
- » Description of proposed redevelopment. Architectural drawings or depictions of proposed work are encouraged as supplementary information but will not be the subject of the formal review. Proposed redevelopment is a secondary consideration to the proposed demolition.

CHAPTER 4

GUIDELINES FOR NEW CONSTRUCTION



Construction of a new addition expanded the footprint of the Pike County Courthouse, which was originally designed by George Barton and built in 1874.

4.1 ADDITIONS

Additions should be sensitively designed to have a minimal impact on historic character. They should respect this historic building's visual prominence and achieve compatibility through appropriate massing, size, and materials. The guidelines in this section are intended to give property owners, architects, and the HARB a set of principles that, when followed, would accommodate change—yet would also help safeguard a building's distinctive form, visual character, and relationship to its neighbors.

An addition to a historic property should be carefully considered. The impact to the individual features and to the public appearance of the building will be important factors in approving proposed designs. The architectural style of the addition should aim to be compatible yet differentiated from the historic building. This can be achieved through sensitive scale and massing, as well as simplified references to character-defining features or ornamentation of the original building. Depending on the building's history, it may already have additions that occurred during the historic district's period of significance and that contribute to the building's historic character. Other existing additions may not relate to the architecture or may detract from it, and can therefore tolerate more change.

The HARB evaluates compatibility according to six factors of the design: **size, scale, and proportion; shape and massing; setback; materials; detailing; and fenestration (windows and doors)**. A proposed addition should consider its main building and the relationship to the surrounding historic district.

Additions to historic or contributing buildings inherently cause alteration of historic fabric. Therefore, the guidelines from Chapter 3: Guidelines for Existing Buildings should be referenced in project planning.

SIZE, SCALE & PROPORTION GUIDELINES

4.1.1 Let the existing height and width of the main building dictate the size of the addition so that it does not compete in size and scale. Appropriate scale should ensure that an addition does not overwhelm the primary building.

4.1.2 Design additions to be lower in height than the main building. Reduced height is generally the most appropriate approach for adding to historic buildings. Avoid additions that exceed the height of the main building.

4.1.3 Consider adjacent properties when sizing an addition. Additions should not encroach on the overall rhythm and spacing of the neighborhood.

4.1.4 Reference the distinctive architectural features of the historic building and use similar forms and proportions to achieve compatibility. For example, maintain proportions of door and window shapes, size, and type; finished floor height; and roof pitch and style.

SHAPE & MASSING GUIDELINES

4.1.5 Respect the massing and footprint of the main building when designing an addition.

4.1.6 Maintain roof forms that complement the existing building. Typically, the shape and pitch of the addition roof should echo that of the main building. Simple shed and flat roofs are also appropriate in lower visibility areas.

4.1.7 Retain existing historic additions. Avoid demolishing additions that date to the building or district's period of significance, as they can provide a physical record of historic development patterns.

4.1.8 Avoid making additions to primary façades. Additions to primary façades of historic buildings are not considered appropriate because they obscure the building's original appearance from the street and diminish the building's integrity.

4.1.9 Avoid adding new porches on primary façades where none existing originally. However, this type of project may be appropriate as a restoration if it replicates an original feature, enhances the patterns of the district, and does not create a false sense of history. The appropriateness of the addition will be evaluated in the context of the specific building and its surroundings.

4.1.10 Design new dormers to be compatible with the existing roof. Dormer additions should not overwhelm the historic roof and should be scaled to preserve the original roof form. New dormers are inappropriately large if they span from end to end of the original roof or if they reach from eave to ridge, or if they occupy the majority of the roof slope's area. Locate new dormers on rear or side roof slopes to reduce visibility. New dormers on primary façades are rarely appropriate, unless reconstructing original dormers based on documentary evidence.

SETBACK GUIDELINES

4.1.11 Locate additions where they will be least visible from the primary street and do not distract from the main building. Additions with little to no visibility will have less of an impact on the historic district.

4.1.12 Construct additions at the rear of a building whenever possible. This approach maintains the historic visual impression of the building as seen from the street, as well as the overall street's pattern and rhythm.

4.1.13 Set back side additions from the primary façade to distinguish the original building and minimize impacts to the streetscape.

4.1.14 Set back rooftop additions or new upper stories from the primary façade to reduce their visibility from the street. Preserve the original roof form as much as possible.

MATERIALS GUIDELINES

4.1.15 Use materials that are similar to those found on the main building. High-quality, durable, and sustainable materials are encouraged. Materials selections can reflect the time of the addition's construction, indicating it is new and not historic, while honoring the key materials and textures of the main building.

4.1.16 Design new porches, decks, or similar exterior spaces to reflect the historic character, architectural detail, and materials of the main building. Traditional wood, brick, and stone materials are appropriate.

4.1.17 Avoid removing or damaging historic materials that remain intact on the main building. Additions should be built so they are reversible and could be removed in the future without further damaging the historic building.

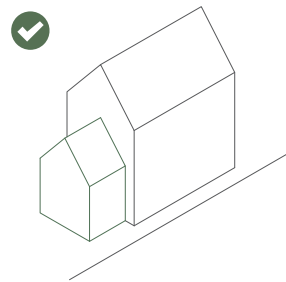

Locate additions on the side or rear façades in a discreet manner that does not diminish the original building's integrity.

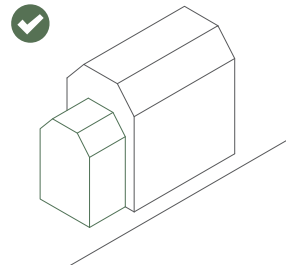

Additions should respect the massing and proportion of the main building, even if it simplifies the design or uses different building materials.

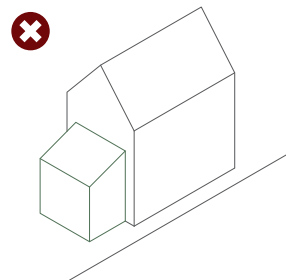

Avoid making additions with a significant difference in architectural style or geometry.

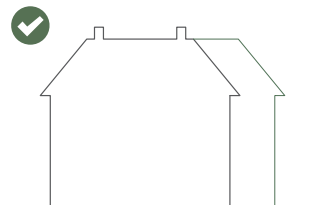

Maintain the shape of the original building.

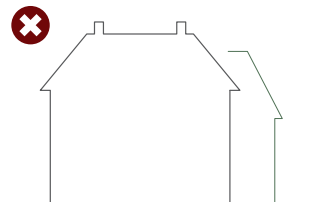

Avoid creating additions that do not follow the proportions or shape of the main building.

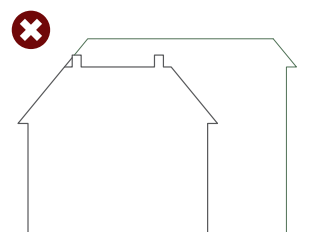

Additions should not exceed the height of the main volume.

DETAILING GUIDELINES

4.1.18 Design decorative features to be compatible with those found on the main building. Simplified interpretations of features are most appropriate. New features can be distinguished from the building's historic features in size, profile, and appearance.

4.1.19 Design an addition to be compatible with the original building and respect its historic character. Avoid designing an addition in a style, scale, and material palette that contrasts with the historic building.

4.1.20 Whenever possible, make alterations and additions in areas that have already been altered. Avoid obscuring remaining character-defining features when designing an addition.

FENESTRATION GUIDELINES

4.1.21 Respect the rhythm and pattern of windows and doors at the main building. Maintain horizontal floor-to-floor alignments and the historic spacing of vertical bays.

4.1.22 Relate the size, shape, proportion, and configuration of windows to the main building's windows. Historic window appearance should be a primary reference for the design of an addition's windows to maintain visual consistency.

REMINDERS FOR APPLICANTS

The compatibility and appropriateness of additions will be evaluated by six factors of its design:

- » Size, Scale & Proportion
- » Shape & Massing
- » Setback
- » Materials
- » Detailing
- » Fenestration (Windows and Doors)

Discussing an addition according to these factors can help applicants and the HARB understand the proposed design on the same terms. Applicants should be prepared to demonstrate how each factor relates to the historic building and the surrounding historic district.

A new addition must also comply with all zoning and code requirements.

EVALUATING ADDITIONS TO NON-CONTRIBUTING RESOURCES

Greater flexibility in design and materials is possible for additions to non-contributing buildings because there are no historic materials that merit preservation. The HARB shall evaluate appropriateness based on the addition's potential impact to the historic district as a whole, rather than the impact to the specific building.

The six evaluation factors will still apply to the proposed work, with the emphasis placed on size, scale, and proportion. Additions to non-contributing buildings should enhance the appearance of the main building and the district.

USEFUL LINKS

For additional guidance about compatible additions, refer to the National Park Service, [Preservation Brief #14 "New Exterior Additions to Historic Buildings"](#)

4.2 NEW BUILDINGS

This section provides design guidelines for construction of new buildings within the Milford Historic District. Although rare, when opportunities arise for new development, new buildings should be harmonious with existing buildings in terms of site placement, massing and height, architectural style, and exterior materials. The objective is to create thoughtful designs that respond to Milford's multi-faceted historic environment and reflect the community's vitality.

The purpose of these guidelines is not to mandate that certain architectural styles be used or that historic styles should be duplicated; rather, cohesion and compatibility are the goals. As with new additions, “compatible yet differentiated” is an important principle that should guide the architectural design of new buildings.

Variation is a character-defining feature of Milford's Historic District and is part of what makes it a unique and interesting place. Infill construction should be sensitive to its immediate surrounding context. Every effort should be made to integrate new construction with the surrounding area and to enhance the aesthetic appeal of the entire historic district.

The HARB evaluates compatibility according to six factors of the design: **size, scale, and proportion; shape and massing; setback; materials; detailing; and fenestration (windows and doors)**. A proposed addition should consider its main building and the relationship to the surrounding historic district.

Demolition of contributing historic buildings for the sole purpose of redeveloping a property with new construction is never appropriate.

SIZE, SCALE & PROPORTION GUIDELINES

4.2.1 Match the overall height of the new building to the surrounding buildings. The height of the roofline(s) should be consistent with the height of the nearby buildings.

4.2.2 For blocks with buildings of different heights, identify the overall pattern and average height to blend the new building into the rhythm of the block.

4.2.3 Design the height of the primary façade(s) and the height of interior floors to be consistent with the surrounding buildings.

4.2.4 Match the height of new building features with the features of surrounding buildings. For example, the height of front porches and front doors should be consistent.

4.2.5 Honor the scale of surrounding buildings. Avoid scaling new construction to be larger than the neighboring buildings and immediate block context.

4.2.6 Consider how the new building relates to the adjacent buildings and the buildings across the street. Maintain the overall size and scale of the block, especially when viewed as a pedestrian.

4.2.7 Respect the overall proportions of surrounding historic buildings in the design of the new façade. Examine the surrounding buildings for horizontal and vertical patterns—such as consistent cornice lines, windows, entrances, roofs, or façades rhythm.

4.2.8 Match the proportion of building features, such as windows or cornices, to surrounding buildings and use consistent proportions across the new building's façades.

SHAPE & MASSING GUIDELINES

4.2.9 Consider simple rectangular volumes rather than elaborate building forms to be consistent with the historic district's massing and character.

4.2.10 If a building is taller than the predominant two-, three-, and four-story height in the historic district, step back any floors that are taller than the average height of historic buildings, so that upper floors are partially concealed when viewed from the street. Taller buildings are not recommended within the district but may be allowed “as of right” by zoning regulations. Balance building elements to produce an appropriately-scaled building. Divide a large building mass by using setbacks and smaller façade modules to reduce perceived mass and height.

SETBACK GUIDELINES

4.2.11 Arrange main entrances to face the street to respect the general historic rhythm of the historic district. Additional entrances may be located on the secondary or rear façades.

4.2.12 For corner lots or buildings with high visibility from multiple public rights-of-way, treat all façades with equal consideration of design, rhythm, and relationship to the streetscape. Generally, the primary façade should face the main (largest) street and orient the entrance to match the dominant pattern of the block. A corner entrance may also be appropriate.

4.2.13 Respect established setbacks and spacing between the buildings already in the historic district. Locate new buildings in-plane with the existing streetwall.

MATERIALS GUIDELINES

4.2.14 Reference the materials appropriate for the surrounding neighborhood's historic character to maintain compatibility. Colors that are part of the material (inherent), such as the color of brick, and textures of nearby historic materials can inform the choice of materials for the new building.

4.2.15 Incorporate local materials and materials that are dominant in the surrounding neighborhood to enhance the overall quality of the streetscape. It is highly encouraged to use sustainable material options.

4.2.16 Avoid vinyl materials, plastics, non-durable materials and materials that are not considered appropriate alternatives for historic materials within these Guidelines.

DETAILING GUIDELINES

4.2.17 Respect historic architectural influences already found in the historic district in the design of new buildings. Employ design strategies that differentiate new development from historic buildings to avoid creating a false sense of history. Simplified details or interpretations of historic features are appropriate design approaches. Avoid directly copying details from an existing building.

4.2.18 Include sustainable construction features such as solar collectors in the design of any new construction to integrate them as seamlessly as possible with the building. Thoughtful planning at the early stages of a design project can help ensure that a historically sensitive design and energy efficiency goals are achieved.

4.2.19 Design new construction to take advantage of energy saving and generating opportunities. This can be accomplished by designing windows to maximize daylighting and using shading that is appropriate in scale, design, and materials, while maintaining compatibility with surrounding properties.

4.2.20 Conceal mechanical and utility equipment from view from the public street(s). If full concealment is not possible, set back equipment and adjust heights to be minimally visible.

FENESTRATION GUIDELINES

4.2.21 Respect the solid-to-void ratio of surrounding historic buildings in the new building. This ratio refers to the amount of exterior wall surface (solid) compared to the size of window and door openings (voids).

4.2.22 Avoid oversized windows and doors that are out of character with the building and the openings in neighboring buildings. Scale windows and doors to be consistent with historic sizes and the pedestrian-oriented scale of the historic district.

4.2.23 Respect the window and door details of surrounding buildings and be consistent with their style and their surrounding context. Use the nearby buildings as references for sills, lintels, and trim.

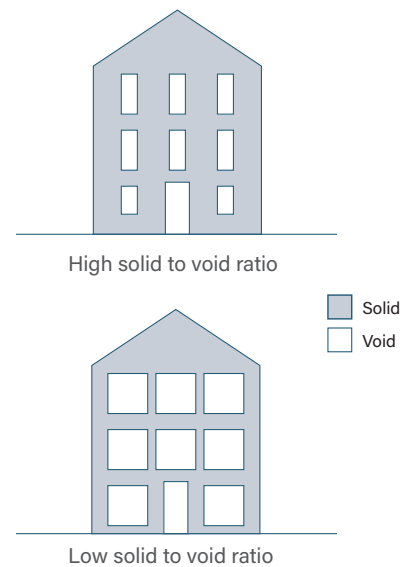

USEFUL LINKS

For additional guidance about new construction, see the National Trust for Historic Preservation's report, "[Regulating New Construction in Historic Districts.](#)"

REMINDERS FOR APPLICANTS

The compatibility and appropriateness of new construction will be evaluated by six factors of its design:

- » Size, Scale & Proportion
- » Shape & Massing
- » Setback
- » Materials
- » Detailing
- » Fenestration (Windows and Doors)

Presenting a proposed new construction using these factors can help applicants and the HARB understand the proposed design on the same terms. Applicants should be prepared to demonstrate how each factor relates to and enhances the surrounding historic district.

New construction must also comply with all zoning and code requirements.

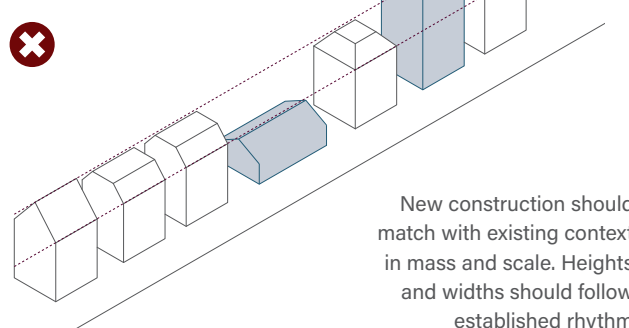
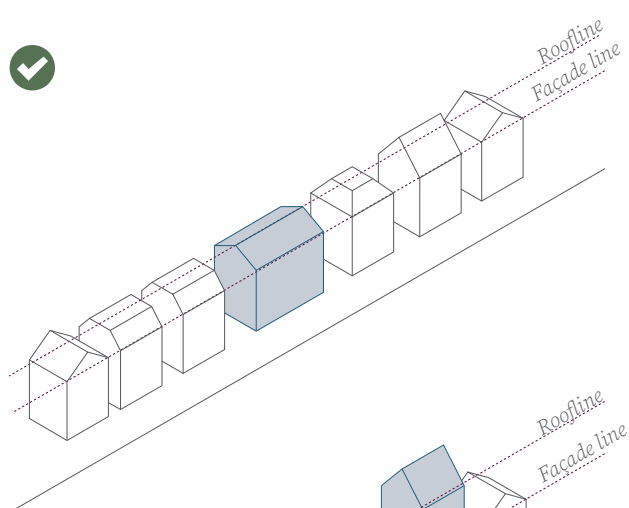

New construction should match with existing context in mass and scale. Heights and widths should follow established rhythm

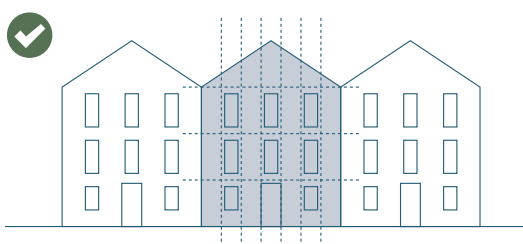

Maintain the overall proportions of windows and doors. Respect façade rhythms, such as the number of bays and symmetry.

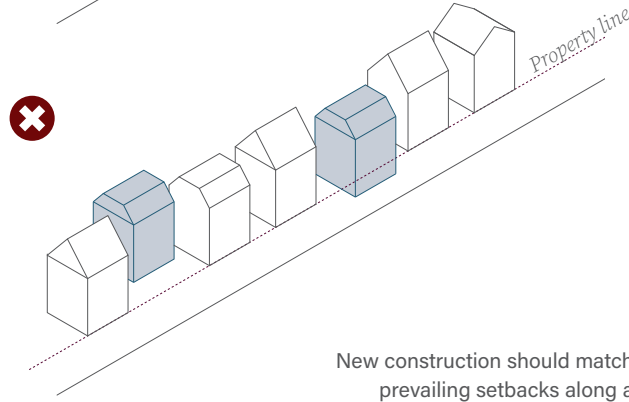
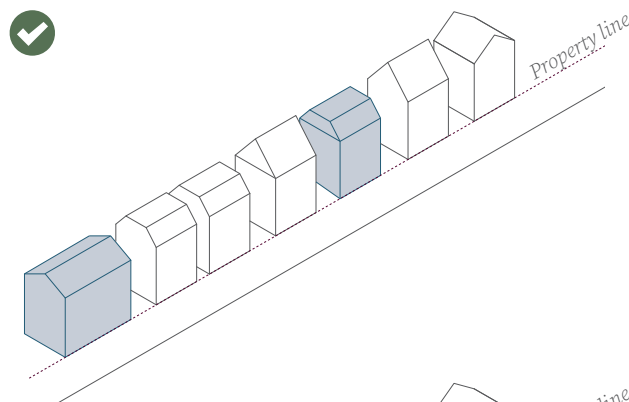

New construction should match prevailing setbacks along a streetscape.

4.3 NEW ACCESSORY BUILDINGS

Construction of accessory structures on unbuilt areas of an existing lot requires careful consideration of the relationship between the main building and the neighboring buildings. Contributing outbuildings and accessory structures are found throughout the historic district and new structures can be appropriate to continue this neighborhood-scale pattern.

New accessory structures include detached garages, outbuildings, sheds, secondary dwelling units, and similar buildings on unbuilt areas of an existing lot.

Demolition of non-original, non-contributing detached garages or outbuildings may be acceptable upon consultation with the HARB, if the new construction will improve the overall appearance of the property.

SIZE, SCALE & PROPORTION GUIDELINES

4.3.1 Scale accessory structures so they do not overwhelm the main building. Keep the height of new accessory structures lower than the height of the main building.

4.3.2 Match the height of nearby accessory structures, especially in highly visible alleys or rear yards.

4.3.3 Respect the overall proportions of the main building. The proportion of building features, such as doors and windows, should be consistent across the new accessory structure and with the proportions of the main building.

SHAPE & MASSING GUIDELINES

4.3.4 Use simple rectangular volumes rather than elaborate forms to complement the main building's massing. Respect the character-defining height, massing, footprint, and roof form(s) of the main building.

SETBACK GUIDELINES

4.3.5 Locate accessory structures at the rear of a property and preserve the primacy of the main building. Minimize visibility from the public street.

4.3.6 Avoid interrupting established setbacks in the surrounding area, whether the setback in relation to the main building or to the street. The grid of secondary alleys is a character-defining feature of the historic district.

MATERIALS GUIDELINES

4.3.7 Consider using materials that are found on the main building or are common within the historic district, such as brick, stone, and wood.

4.3.8 Avoid vinyl materials, plastics, non-durable materials and materials that are not considered appropriate alternatives for historic materials within these Guidelines.

DETAILING GUIDELINES

4.3.9 Design accessory structures to be compatible with the main building's architectural style and details. Consider simplified details or interpretations of historic features on the main building.

FENESTRATION GUIDELINES

4.3.10 Respect the size, shape, and solid-to-void ratio of the main building's windows and doors.

4.3.11 Avoid oversized windows and doors that are out of character with the main building and/or nearby accessory structures that contribute to the district character.

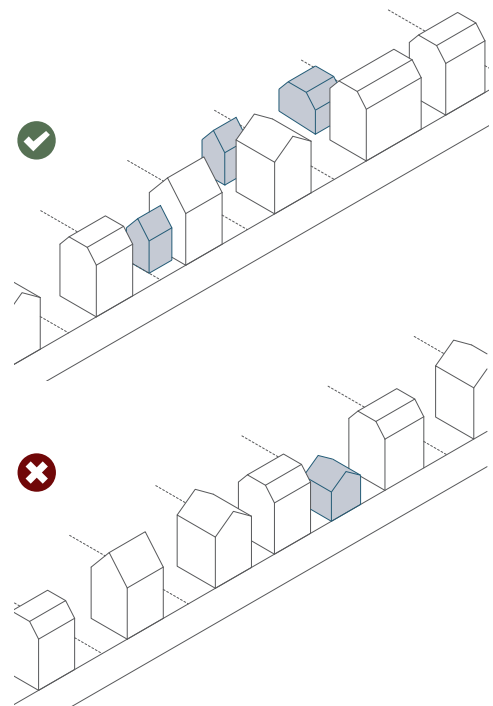

New accessory structures should respect the historic building in style, scale, setback, and overall relationship to surroundings.

CHAPTER 5

FURTHER RESOURCES



The Presbyterian Church at 300 Broad Street (1874), designed by George Barton is a well-preserved example of religious architecture in the Milford Historic District. Its steeple and clock tower are unique features in the district.

5.1 GLOSSARY

Adaptive reuse: The process by which structurally sound older buildings are developed for economically viable new uses. Such buildings may be historically important, architecturally distinctive, or simply underutilized.

Asphalt shingles: Shingles made from roofing felt coated with asphalt and mineral granules.

Bay window: The common term for a minor projection containing a window that extends beyond the surrounding façade plane.

Brick stitching: A repair technique which removes deteriorated bricks in full size units, from joint to joint in the area of cracking or deterioration. New bricks, matching the original in strength, dimension, pattern, texture and color are “stitched” or set into place where the damaged or missing units were located. The new bricks are set in mortar and pointed to match the original mortar.

Casement window: A window with the sash hinged on the jamb (vertical side member).

Clapboard siding: A siding material consisting of narrow wood boards applied horizontally, with the lower edge overlapping the board below.

Compatible. The ability of alterations and new designs to be located in or near historic properties and districts without adverse effect. Some elements affecting design compatibility include location, height, scale, mass and bulk of structures; building materials; architectural details; circulation and access; landscaping; and parking impacts. Compatibility refers to the sensitivity of development proposals in maintaining the character and context of historic properties and districts.

Composite patch repair: A repair treatment carried out by patching selected areas of deteriorating masonry with a cementitious, mortar material.

Conservation: The measures taken to extend the life of cultural heritage and historic fabric of the built environment. The aim of conservation is to maintain the physical and cultural characteristics of the object to ensure that its value is not diminished and that it will outlive our limited time span.

Consolidation repair: Chemical compounds, both organic and inorganic, which enact a process of stone consolidation, which fortifies weathered stone and wood, while simultaneously warding against further deterioration.

Cornice: The common name for the decorative projecting element at the top of a façade; commonly bracketed and located above a frieze.

Crack repair: A repair technique in which the crack is routed out, creating a clean void that is then injected with grout to seal the opening.

Dormer: A minor projection on a pitched roof, usually bearing a window on its front face. Dormers can have a variety of roof forms.

Dutchman repair: A type of piecing-in repair, typical for masonry and wood. In areas where materials is missing or requires a patch, a hole is carefully squared off and the patch carried out with a piece of matching material set into the hole and secured.

Eave: The lower edge of a roof slope that intersects with the exterior wall.

Efflorescence: A process and condition where water-soluble salts leached out of masonry or concrete by capillary action by evaporation and white haze or powdery surface deposits remain.

Façade: An exterior building face.

Fenestration: The physical arrangement of windows on a building's exterior walls.

Fixed window: A window sash that does not move or open.

Flashing: Thin metal sheets used to prevent moisture infiltration at joints of roof planes and between the roof and vertical surfaces.

Gable: The upper area of an exterior wall that is located between the roof slopes.

High style: A building that has all of the details associated with a specific architectural style and is considered an "academic" or "pure" example of the style.

Hipped roof: A roof form where all sides slope between the roof ridge and eaves.

Hung sash window: A window in which one or more sashes move vertically.

Infill: New construction located within an existing, historic setting

In-Kind: The replacement of an element with a new element of the same material, color, texture, shape and form as the original. Often used interchangeably with "like-for-like."

Integrity: The ability of a historic property to convey its significance through aspects of location, design, setting, materials, workmanship, association, and feeling. Synonymous with "historic integrity" in National Park Service use.

Lite: A piece of glass located within a window. Commonly also spelled as "light."

Massing: The distribution of a building's volume through space. The overall size, height, shape and composition of the exterior of volumes of a building, especially when the structure has major and minor elements.

Muntin: A narrow member that separates the lites within a window sash.

Non-contributing building: Building or structure in historic district that does not have historic, architectural, cultural, or archaeological significance and is not part of the historic district's reason for being designated; sometimes referred to as a "non-contributor" or a "non-contributing resource."

Parapet: The area of a building's exterior walls where they extend above a roof; it can be flat or stepped/shaped.

Porch: A component of a building that shelters a building entrance and contains occupiable space.

Preservation: The act or process of applying measures necessary to sustain the existing form, integrity, and materials of an historic property. Work, including preliminary measures to protect and stabilize the property, generally focuses upon the ongoing maintenance and repair of historic materials and features rather than extensive replacement and new construction.

Primary Façade: The exterior face of a building at the street or public right-of-way and/or the face of the building with the main entrance. The primary façade is usually distinguished by architectural features or ornamental details.

Proportion: The relationship of the size, shape, and location of one building element to all the other elements.

Reconstruction: The re-creation of vanished buildings or building features on their original site. This is one of the most radical levels of intervention. It is also one of the most hazardous culturally: all attempts to reconstruct the past, no matter what academic and scientific resources are available, necessarily involve subjective hypothesis.

Rehabilitation: The act or process of making possible a compatible use for a property through repair, alterations, and additions while preserving those portions or features which convey its historical, cultural, or architectural values.

Repair: The process of restoring to good or sound condition after decay or damage.

Replication: The creation of a mirror image of an existing building or building feature. The construction of an exact copy of a detail or feature removed from the original.

Restoration: The act or process of accurately depicting the form, features, and character of a property as it appeared at a particular period of time by means of the removal of features from other periods in its history and reconstruction of missing features from the restoration period.

Secondary façade: A building face that does not front on the main street, or does not contain the building's main entrance but does front a street or public right-of-way. "Contributing" secondary façades have some important architectural features and are visually supporting the primary façade. "Non-contributing" secondary façades do not have important architectural features.

Setback: The distance between a property line and a building, especially at the front of a lot.

Shed roof: A roof form characterized by a single slope.

Simulated divided lite / light: A window in which two panes of glass are assembled in the sash and imitate the appearance of true divided lites using exterior muntin bars or interior spacer bars sandwiched between the glass. Often abbreviated as SDL.

Spalling: Chipping, flaking, and small areas of material loss at the face of masonry units or concrete.

Streetscape: The visual character of a roadway's setting, including paving, plant life, and adjacent buildings and structures.

Stucco: An exterior finish composed of some combination of portland cement, lime and sand, which are mixed with water and applied to a wall in a wet coating and allowed to dry.

Surface-to-void ratio: The proportional relationship between solid wall areas and window/door openings.

Transom: A horizontal window opening above a door or window.

True divided lite / light: A window in which individual panes of glass or lites are assembled in the sash and divided using muntins.

Weatherstripping: A narrow compressible band used between the edge of a window or door and the jambs, sill, head and meeting rail to seal against air and water infiltration.

Window sash: The overall frame that contains the glazing and possibly muntins of a window.

Vernacular: A building that does not have details associated with a specific architectural style but is a simple building with modest detailing and form, often related to local designations. Historically, factors often influencing vernacular building were things such as local building materials, local climate and building forms used by successive generations.

5.2 MILFORD'S ARCHITECTURAL STYLES

Few buildings exhibit all features of an architectural style. In the past and even today, each architect, builder, or craftsman expressed their unique tastes and skills that reflected a period's technological and stylistic advancements. With this in mind, recognizing architectural styles and individual features is an important step to increase the overall appreciation and understanding of Milford's built environment. While a building may not have all features of a particular style, it can still be consistent with that style.

The architectural styles found in the historic district include those of general Italianate design, and other styles including; Greek Revival, Romanesque Revival, Second Empire, Queen Anne, Neo-Classical, Tutor Revival, etc. Examples of vernacular adaptation of many of the popular styles are found throughout the district.

This section of the Guidelines is intended to familiarize the community with the styles often found in Milford. The time frames are approximate, indicating the period of the style's popularity but not necessarily the construction date of a specific building. Typical character-defining features for each style are noted, as a resource to identify these details throughout the historic district and borough.

"Character-defining features" are the parts of a building that define its style. They are what makes a historic building distinctive. When looking at a building, these are the types of questions that can help identify character-defining features:

- » Overall: How tall is it? What material is it built of? What shape is the roof?
- » Primary Façade: What do the windows and doors look like? How are they spaced across the building? Is there a porch, tower, or other elements?
- » Details: Is there ornament around the windows and doors? What does it look like where the walls meet the roof? Do these details look like the details at nearby buildings?

It is important to keep in mind that local style variations happen over time. An individual building may be a hybrid style that mixes characteristics from different styles or may have unusual features. Identifying a building's character-defining features should take into account its unique history and its overall appearance.



USEFUL LINKS

For additional information about character-defining features, see the National Park Service, [Preservation Brief #17: "Architectural Character—Identifying the Visual Aspects of Historic Buildings as an Aid to Preserving their Character"](#)

COMMON BUILDING VOCABULARY

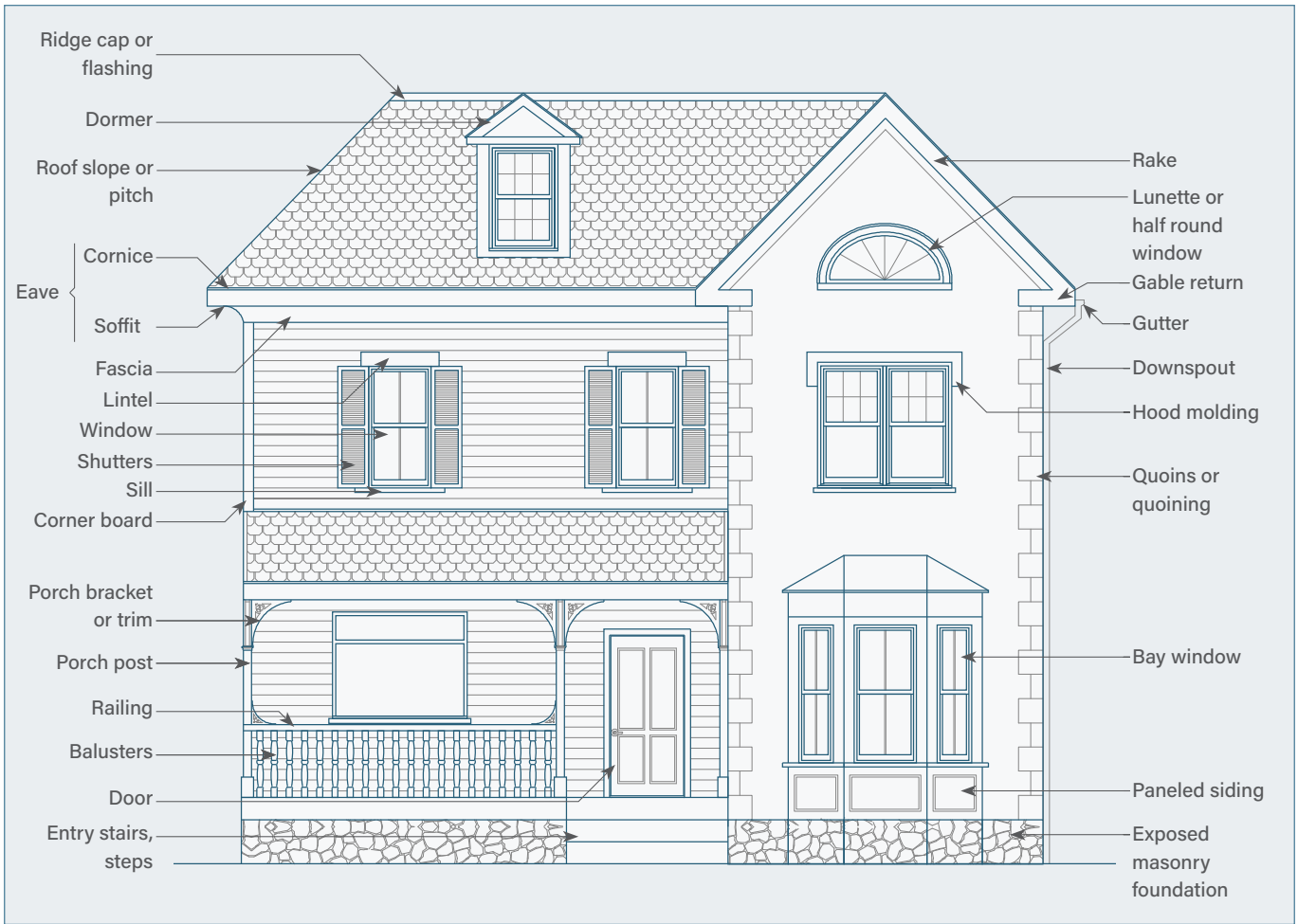

HOW TO READ A BUILDING

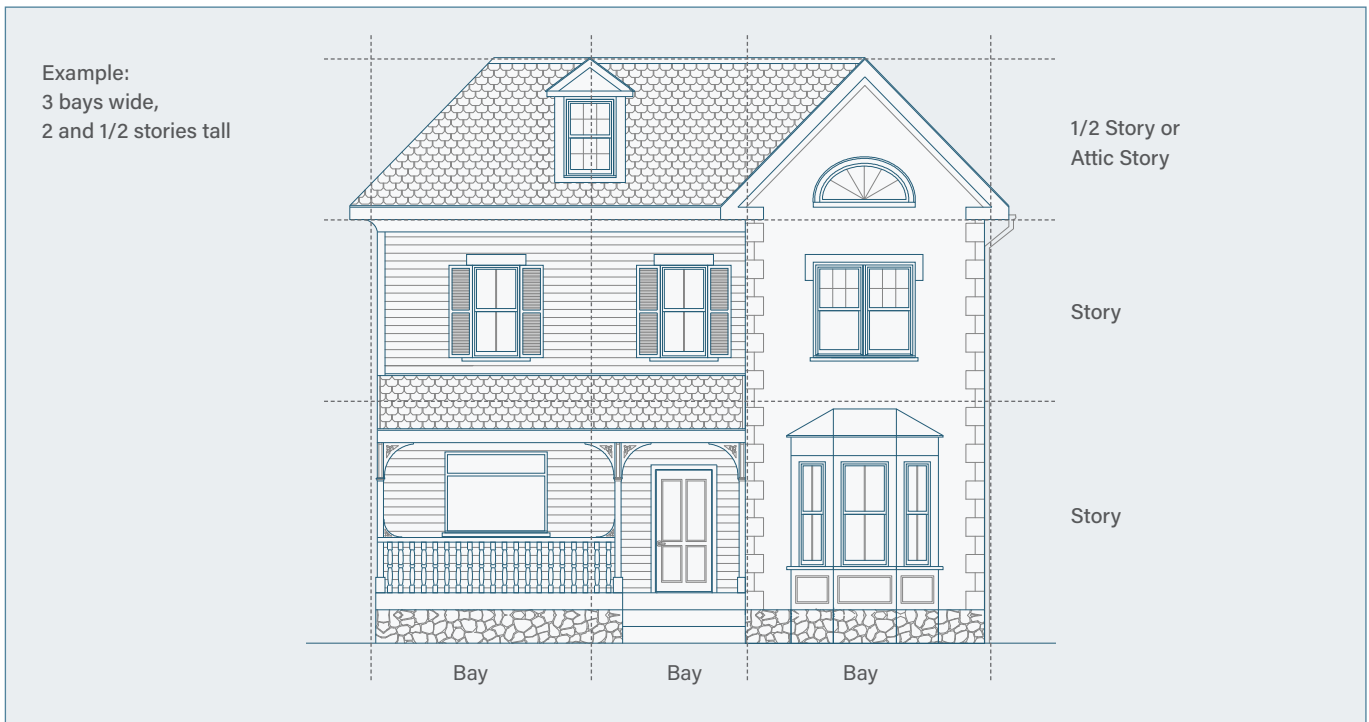

GREEK REVIVAL (1830-1860)



In contrast to earlier American styles influenced by English building fashions, the Greek Revival style arose from the nation's desire to identify with the democratic ideals and architecture of ancient Greece. In Milford, there are few structures that fully exemplify this style.

The style's focus shifted from the long side of the house to the short-gabled end. A three-bay façade and side hall plan differed from the symmetrical Federal style. Roofs are usually gable of medium pitch, sometimes with a low, triangular pediment, and chimneys are modest in presence. It also has a recessed and off-centered doorway framed by narrow floor-length sidelights and a transom flanked by flat pilasters and an architrave. It is common for Greek Revival style buildings to have full width porches or porticos. Typically, exterior finishes are clapboards or matched flat-boards designed to resemble stone. To follow the classical formalities, there is an emphasis on simple lines, pilasters, and columns to display a Greek temple's appearance.

Character-defining features

- ① Pediment (Entablature)
- ② Gable end to the street
- ③ Shutters
- ④ 6/6 Sash
- ⑤ Paneled pilasters or wide corner boards
- ⑥ Clapboards or flat-boards
- ⑦ Off-center entry with flat pilasters, entablature, side, transom lights & 4-panel door

ITALIANATE (1850-1890)



The Italianate style is inspired by the vernacular farmhouse architecture of the Italian country villas. However, especially in Milford, few buildings fully exemplify the style in an academic definition. Italianate elements were often combined with other styles of the period like Second Empire or Queen Anne.

Typical characteristics include an asymmetrical massing that reflects the interior floor plan. The use of wings, towers, and bay windows is particularly common. The roof usually has a slight pitch, and it can be gabled, hipped, or a combination of both. Entrance includes heavily molded doors, often double and asymmetrical placement with heavy wooden bracketing. Windows are tall and slender, often two-over-two with the presence of paired arched windows. Details and materials include wood with frequent use of flat-boards and heavy wood brackets with multiple forms under the eaves and over the doors and windows.

Character-defining features

- ① Towers or cupolas
- ② Wing or ell volumes, irregular plan
- ③ Shallow roof pitch
- ④ Brackets, either single or double.
- ⑤ Paired windows & 2/2 sash
- ⑥ Horizontal band
- ⑦ Semi-circular arch
- ⑧ Projecting porches and window bays

VERNACULAR (1850-1900)



Vernacular refers to structures that draw on local architectural forms and a combination of elements from other recognized styles. Milford's vernacular homes are often two-storied, three-bayed, with a gable roof type. However, around the borough, the vernacular style holds a number of variations, including the presence of a second floor porch.

Usually, Vernacular buildings have a L-shaped, rectangular, or square hall plan and three-bay façade arrangement, retaining symmetry in its construction. Entrances are frequently located in the center, alongside a central stair hall with rooms on either side. Prominent porches, often veranda typologies, have ornamental detailing on their pilasters or columns with a simple, flat entablature. At the ends of the building, there are usually tall and slender chimneys. Building materials typically include brick or wood, simple in detail and decoration.

Character-defining features

- ① Gable, often cross gabled roofs
- ② Vertical emphasis through roof details or dormers
- ③ Exterior cladding of clapboard or masonry
- ④ 6/6 or 12/12 lite/light windows, often grouped in pairs
- ⑤ Prominent porches, often with ornaments
- ⑥ Tall and narrow doors
- ⑦ Wood or brick construction

SECOND EMPIRE (1870-1890)

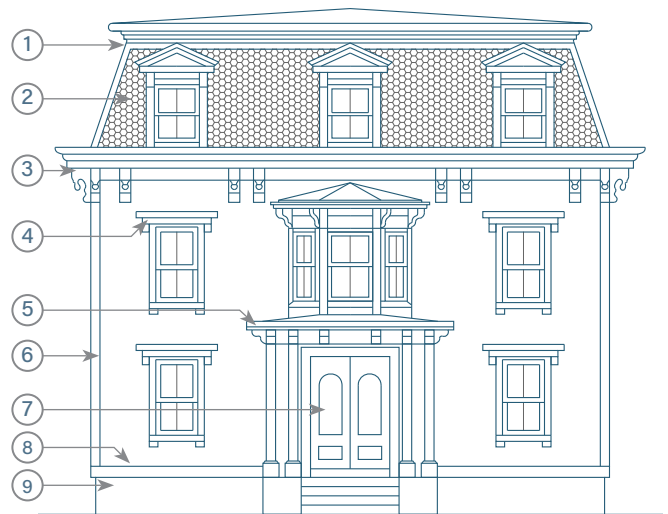

Buildings of the Second Empire style are imposing, boldly modeled, with a "three-dimensional" effect. In Milford, there are few structures that fully exemplify this style.

The main characteristic of the style is the high mansard roof often with dormers enclosing the top floor on all sides. Usually, it is a central hall plan, with a three- or five-bay façade with a central entrance. Over time, some of these buildings became asymmetrical because of the addition of rooms and porches. The windows are usually slender and elongated. Mainly, dormer windows appeared in a variety of shapes and were decorated with pediments and brackets. Building materials include wood or brick commonly finished with flat-boards. Other significant features include ornate moldings and brackets as well as spacious porches or verandas in some cases, sharing features with the Italianate style.

Character-defining features

- ① Mansard roof
- ② Decorative slate roofing
- ③ Deep bracketed eaves
- ④ Bracketed window hoods
- ⑤ Projecting portico
- ⑥ Corner boards
- ⑦ Paired doors & windows
- ⑧ Sill board
- ⑨ High foundation

QUEEN ANNE (1880-1900)

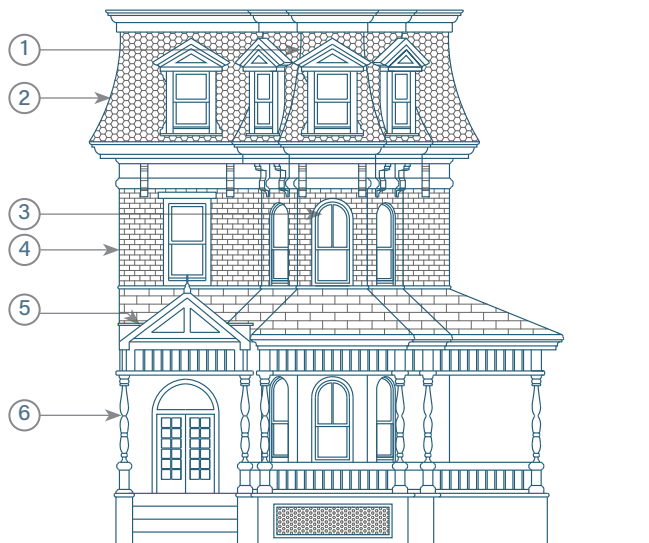

The Queen Anne style in Milford emerges as an eclectic style that incorporated both classical and medieval forms of ornamentation. Contrasting materials are used for a picturesque effect.

The Queen Anne style is most noted for its combination of original and historical motifs in varying shapes, materials, colors, and textures for a visually picturesque effect. The style typically identifies multiple roof lines and prominent porch detailing with intricate spindle work. High-style examples have elaborate façades with various projections and free-form massing. Even simple vernacular examples usually have a cross gable roof, which may be articulated by an ornate cornice. Porches dominate the first story. Turned wood columns on porches, corner turrets or towers, and bay windows are also prominent features.

Character-defining features

- ① Asymmetrical massing usually with tower or turret
- ② Multiple roofs, clad with shingles
- ③ Bay and ornamental window
- ④ Mixed exterior materials, usually brick and wood
- ⑤ Full-width porch
- ⑥ Turned wood posts

NORMAN REVIVAL (1870-1890)



The Norman Revival style is inspired by the 13th and 14th century French castles. In Milford, only a few buildings fully exemplify the style in an academic definition, most notably Forest Hall at 206-216 Broad Street. Elements were often used in tandem with classical architecture elements, especially from the Gothic revival style including rounded arches and rusticated masonry.

Typical characteristics include near symmetry in façade and plan. The use of gables, towers, and dormers are also particularly common. Entrance includes wooden, often ornamental doors, often with symmetrical placement between exposed wooden framing or stone façades. Windows are typically paired and resemble small doors with their mullion divisions. Additional windows may take on oval geometries. Details and materials include wood and stonework.

Character-defining features

- ① Gabled Roofs and stone chimney elements
- ② Dormers or extensions of the façade
- ③ Arched or circular ornamental details
- ④ Exposed wood framing elements
- ⑤ Rusticated masonry exterior
- ⑥ Paired 6/6 or 12/12 windows
- ⑦ Windows that often resemble small doors

COLONIAL REVIVAL (1890-1930)



The Colonial Revival style was popularized nationally by reflecting America's Colonial past. It included exaggerated antique styles in its architecture.

Most constructions that follow the Colonial Revival style usually accent the front door, either with a decorative pediment supported by pilasters or by projecting it forward, supporting it by slender columns to form an entry porch. Commonly, doors include overhead fanlights or sidelights. The overall façade shows symmetrically balanced windows and center doors. Windows are generally double-hung in adjacent pairs, usually with multi-pane glazing in one or both sashes.

Character-defining features

- ① Windows with double-hung sashes. Usually with multi-pane glazing
- ② Windows frequently in adjacent pairs
- ③ Accentuated front door, normally supported by pilasters

CRAFTSMAN (1900-1930)



Craftsman style buildings are found throughout Milford. They are most commonly in a Bungalow form. This form is found at various residences in the Milford Historic District. The style is characterized by its short stature, often one to one-and-one-half stories in height, with simple natural presenting materials. Low gabled hip roofs are typical, often with exposed rafters. Exposed wooden beams are often visible in major rooms.

A Craftsman-style bungalow is most noted for its full-width porch, which is characterized by large supporting columns, and its broad and symmetrical proportions. Several stores once offered prefabricated Craftsman-style homes in their mail order catalogs to be assembled by local workers for low prices.

Character-defining features

- ① One to one-and-one-half stories in height
- ② Low gabled, or hipped roofs with typically a single large dormers
- ③ Windows usually double-hung with multiple panes
- ④ Full-width porch, supported by large square columns

5.3 ABBREVIATIONS

CoA: Certificate of Appropriateness

HARB, or ARB: Historical Architectural Review Board, Architectural Review Board

LHD: Local Historic District

PA SHPO: Pennsylvania State Historic Preservation Office

PA-SHARE: Pennsylvania Cultural Resource Information System

PHMC: Pennsylvania Historic and Museum Commission

NR, or National Register: National Register of Historic Places

NPS: National Park Service

Staff: Borough Secretary and HARB Staff

The Standards: The Secretary of the Interior's Standards for the Treatment of Historic Properties, the Standards for Rehabilitation.

5.4 PRESERVATION INCENTIVES

FEDERAL HISTORIC PRESERVATION TAX INCENTIVES

A property must be listed on or eligible for listing on the National Register of Historic Places to eligible for the Federal Historic Preservation Tax Credit, also commonly referenced as the Rehabilitation Tax Credit. A 20% income tax credit is available for the rehabilitation of historic properties. Properties must also be income-producing to apply, which means that owner-occupied residences are not eligible. Proposed work at historic properties pursuing the tax credit must comply with the Standards for Rehabilitation.

For more information, refer to the National Park Services' [Tax Incentives for Preserving Historic Properties website](#).

PENNSYLVANIA HISTORIC PRESERVATION TAX CREDIT PROGRAM

The Pennsylvania Department of Community and Economic Development manages the state-level Historic Preservation Tax Credit program. Similar to the federal program, a property that is listed in or eligible for listing in the National Register of Historic Places and is income-producing may apply for a tax credit. Under the state program, a rehabilitation project is eligible to receive up to 25% of the cost of the rehabilitation in tax credits, and up to 30% if connected to a workforce housing project. The state credit can be paired with federal rehabilitation tax credits.

For more information, refer to the Pennsylvania Department of Community and Economic Development's [Historic Preservation Tax Credit website](#).

5.5 PRESERVATION RESOURCES

If reading this document digitally, all [hyperlinks](#) will lead to the organization's website or published work.

MILFORD RESOURCES

Milford Borough, [Milford Borough Comprehensive Plan Update \(2020\)](#)

Historic Preservation Trust of Pike County, [Milford Presents](#)

PENNSYLVANIA RESOURCES

[Pennsylvania Historical & Museum Commission \(State Historic Preservation Office\)](#)

[PA-SHARE: Pennsylvania Cultural Resource Information System](#)

NATIONAL RESOURCES

[National Park Service, Technical Preservation Services](#)

Featured National Park Service resources:

Preservation Briefs. Washington, DC: National Park Service, Technical Preservation Services. [Online publications](#).

Grimmer, Anne E. *The Secretary of the Interior's Standards for the Treatment of Historic Properties with Guidelines for Preserving, Rehabilitating, Restoring & Reconstructing Historic Buildings*. Washington, DC: National Park Service, Technical Preservation Services, 1995, rev. 2017. [Online publication](#).

[Preservation By Topic Index](#) for online resources.

[Sustainability](#) resources and guidance.

[National Center for Preservation Technology & Training](#)

[National Trust for Historic Preservation](#) and the National Trust's [Preservation Leadership Forum Association for Preservation Technology](#)

Borough of Milford, Pennsylvania
Historical Architectural Review Board

Revised Public Review Draft
December 2022